



NPP2018 Cordless Pole Saw

INSTRUCTION MANUAL

**IF YOU SHOULD HAVE A QUESTION OR
EXPERIENCE A PROBLEM WITH YOUR
BLACK & DECKER PRODUCT**

**CALL AUSTRALIA 1-800-654 155
NEW ZEALAND 64 9579 7600**

BEFORE YOU CALL, HAVE THE FOLLOWING INFORMATION
AVAILABLE, CATALOG No., TYPE No., AND DATE CODE (e.g. 0130M).
IN MOST CASES, A BLACK & DECKER REPRESENTATIVE CAN
RESOLVE YOUR PROBLEM OVER THE PHONE IF YOU HAVE A
SUGGESTION OR COMMENT, GIVE US A CALL. YOUR FEEDBACK IS
VITAL TO BLACK & DECKER.

KEY INFORMATION YOU SHOULD KNOW:

- Charge battery for 2 hours before first use.
- **DO NOT OVER-TENSION CHAIN.** Refer to "ADJUSTING CHAIN TENSION" for proper method of tensioning chain.
- Retighten chain frequently during first two hours of use.



SAVE THIS MANUAL FOR FUTURE REFERENCE.

⚠ IMPORTANT SAFETY RULES

⚠ WARNING: Read and understand all instructions. Failure to follow all instructions listed below may result in electric shock, fire and/or serious personal injury.

SAVE THESE INSTRUCTIONS

Before Operating Pole Saw

- For safe operation, read and understand all instructions before using the Pole Saw. Follow all safety instructions. Failure to follow all safety instructions listed below, can result in serious personal injury.
- Watch what you are doing. Use common sense. Do not operate Pole Saw when you are tired.
- Use Pole Saw for cutting wood only. Do not use Pole Saw for purpose not intended. Do not use for cutting non-wood items.
- Only well-instructed adults should operate Pole Saw. Never allow children to operate.
- Do not allow children or untrained individuals to use this unit.
- Wear the following safety gear when operating Pole Saw:
 - heavy-duty gloves
 - steel-toed safety footwear with non-skid soles
 - safety glasses, goggles or face screen that are marked to comply with ANSI Z87
 - safety hard hat
 - ear muffers or ear plug
 - face or dust mask (if working in dusty areas)
- Wear heavy long pants and boots. Do not wear loose fitting clothing, short pants, jewelry of any kind, or go barefoot.
- Secure long hair so it is above shoulder level to prevent entanglement in any moving parts.
- Before cutting, always provide the following:
 - clear work area
 - secure footing
 - planned retreat path from falling limbs

- Inspect tree before trimming. Make allowance for branches to fall freely to the ground.
- Do not use your Pole Saw to fell saplings.

While Operating Pole Saw

- Stay alert. Use common sense while operating the unit.
- Keep work area clean. Cluttered areas invite injuries.
- Keep children, animals and bystanders at least 50 ft. (15 m) away from Pole Saw. Only Pole Saw user should be in work area.
- Do not use the Pole Saw to cut down trees.
- Grip Pole Saw securely - one hand on the pole, the other on the handle.
- Keep finger off trigger until ready to make cut.
- Before starting Pole Saw, make sure chain is not touching anything.
- Keep all parts of body away from chain when Pole Saw is running.
- Do not force Pole Saw while cutting. Apply light pressure. It will do the job better and safer at the rate for which it was intended.
- Carry Pole Saw from one place to another
 - with battery removed
 - by holding pole at balance point
 - with guide bar and chain to rear and with scabbard attached
- Do not cut small brush and saplings with the Pole Saw. Slender matter may catch in the chain and be whipped toward you. This could also pull you off balance.
- Do not operate in poor lighting.
- Keep firm footing and balance. Do not overreach. Overreaching can result in loss of balance or exposure to hot surfaces.
- Keep all parts of your body away from any moving part.
- Do not, under any circumstance, use any attachment or accessory on this product, which was not provided with the product, or identified as appropriate for use with this product in this Instruction Manual.

Do not operate Pole Saw:

- while under the influence of alcohol, medication, or drugs
- in rain or in damp or wet areas
- where highly flammable liquids or gases are present

- if Pole Saw is damaged, adjusted wrong, or not fully and securely assembled
- if trigger does not turn Pole Saw on and off. Chain must stop moving when you release trigger. Have faulty switch replaced by authorized service center. See “Service Information”.
- while in a hurry
- while in tree or on a ladder
- while on aerial booms, buckets or platforms
- during high wind or storming weather

General Safety Rules

⚠ WARNING: Shock Hazard. To protect yourself from electrocution, do not operate within 50 feet (15 m) of overhead electrical lines. Failure to do this could result in severe personal injury.

- To protect yourself from falling branches do not stand directly under the branch or limb being cut. This unit should not be held at an angle over 60 degrees from ground level.
- Keep the handles dry, clean, and free of oil.
- Before you start the unit, make sure the chain is not contacting any object.
- Make sure the cutting chain has stopped before setting the unit down.

Service

- **Tool service must be performed only by qualified repair personnel.** Service or maintenance performed by unqualified personnel could result in a risk of injury. See “Service Information”.
- **When servicing a tool, use only identical replacement parts. Follow instructions in the Maintenance section of this manual.** Use of unauthorized parts or failure to follow Maintenance Instructions may create a risk of electric shock or injury.

Guard Against Kickback

⚠ WARNING: KICKBACK may occur when the nose or tip of the guide bar touches an object, or when the wood closes in and pinches the saw chain in the cut. Tip contact in some cases may cause a lightning fast reverse reaction, kicking the guide bar up and back towards the operator. Pinching the saw chain along the top of the

guide bar may push the guide bar rapidly back towards the operator. Either of these reactions may cause you to lose control of the saw which could result in serious injury to user.

The following precautions should be followed to minimize kickback:

- Grip Pole Saw firmly. Hold the saw firmly with both hands when the unit is running. Use a firm grip with thumbs and fingers encircling the saw handle and pole.
- Do not over reach.
- Keep proper footing and balance at all times.
- Don't let the nose of the guide bar contact a log, branch, ground or other obstruction.
- Do not extend Pole Saw handle above shoulder height.
- Use devices such as low kickback chain, chain braking system and special guide bars that reduce the risks associated with kickback.
- Only use replacement bars and chains specified by the manufacturer or the equivalent.
- Never let the moving chain contact any object at the tip of the guide bar.
- Keep the working area free from obstructions such as other trees, branches, rocks, fences, stumps, etc. Eliminate or avoid any obstruction that your saw chain could hit while you are cutting through a particular log or branch.
- Keep your saw chain sharp and properly tensioned. A loose or dull chain can increase the chance of kickback. Check tension at regular intervals with the motor stopped and battery removed.
- Begin and continue cutting only with the chain moving at full speed. If the chain is moving at a slower speed, there is a greater chance for kickback to occur.
- Cut one branch at a time.
- Use extreme caution when re-entering a previous cut. Engage spiked bumpers into wood and allow chain to reach full speed before proceeding with cut.
- Do not attempt plunge cuts or bore cuts.
- Watch for shifting branches or other forces that could close a cut and pinch or fall into chain.

Kickback Safety Features

⚠ **Warning:** The following features are included on your Pole Saw to help reduce the hazard of kickback; however such features will not totally eliminate this dangerous reaction. As a chain saw user do not rely only on safety devices. You must follow all safety precautions, instructions, and maintenance in this manual to help avoid kickback and other forces which can result in serious injury.

- **Reduced-Kickback Guide Bar**, designed with a small radius tip which reduces the size of the kickback danger zone on bar tip. A reduced- kickback guide bar is one which has been demonstrated to significantly reduce the number and seriousness of kickbacks when tested in accordance with safety requirements for electric chain saws.
- **Low-Kickback Chain**, designed with a contoured depth gauge and guard link which deflect kickback force and allow wood to gradually ride into the cutter. A low-kickback chain is a chain which has met kickback performance requirements of ANSI B175.1 when tested on the representative sample of chain saws.

⚠ Specific Safety Rules

- **Hold tool by insulated gripping surfaces when performing an operation where the cutting tool may contact hidden wiring.** Contact with a "live" wire will make exposed metal parts of the tool "live" and shock the operator.

⚠ **WARNING:** Some dust created by power sanding, sawing, grinding, drilling, and other construction activities contains chemicals known to cause cancer, birth defects or other reproductive harm.

Some examples of these chemicals are:

- lead from lead-based paints,
- crystalline silica from bricks and cement and other masonry products, and
- arsenic and chromium from chemically-treated lumber. (CCA)

Your risk from these exposures varies, depending on how often you do this type of work. To reduce your exposure to these chemicals:

work in a well ventilated area, and work with approved safety equipment, such as those dust masks that are specially designed to filter out microscopic particles.

- **Avoid prolonged contact with dust from power sanding, sawing, grinding, drilling, and other construction activities. Wear protective clothing and wash exposed areas with soap and water.** Allowing dust to get into your mouth, eyes, or lay on the skin may promote absorption of harmful chemicals.

⚠ **WARNING: Use of this tool can generate and/or disburse dust, which may cause serious and permanent respiratory or other injury.** Always use NIOSH/OSHA approved respiratory protection appropriate for the dust exposure. Direct particles away from face and body.

SAVE THESE INSTRUCTIONS

The label on your tool may include the following symbols.

V.....volts	Aamperes
Hz.....hertz	Wwatts
minminutes	~alternating current
====direct current	nOno load speed
☐Class II Construction	⊖.....earthing terminal
⚠safety alert symbol	.../minrevolutions orper minute

Battery Cap Information

Battery storage and carrying caps are provided for use whenever the battery is out of the tool or charger. Remove cap before placing battery in charger or tool.

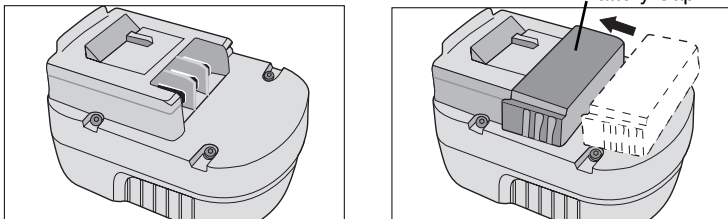

⚠ WARNING: Do not store or carry battery so that metal objects can contact exposed battery terminals. For example, do not place battery in aprons, pockets, tool boxes, product kit boxes, drawers, etc. with loose nails, screws, keys, etc. without battery cap. Transporting batteries can possibly cause fires if the battery terminals inadvertently come in contact with conductive materials such as keys, coins, hand tools and the like. "The US Department of Transportation Hazardous Material Regulations (HMR) actually prohibit transporting batteries in commerce or on airplanes (i.e. packed in suitcases and carryon luggage) UNLESS they are properly protected from short circuits. So when transporting individual batteries, make sure that the battery terminals are protected and well insulated from materials that could contact them and cause a short circuit."

⚠ Safety Warnings and Instructions: Charging

1. This manual contains important safety and operating instructions.
2. Before using battery charger, read all instructions and cautionary markings on (1) battery charger, (2) battery, and (3) product using battery.

3. **⚠ CAUTION:** To reduce the risk of injury, charge only Black & Decker Batteries. Other types of batteries may burst causing personal injury and damage.
4. Do not expose charger to rain or snow.
5. Use of an attachment not recommended or sold by Black & Decker may result in a risk of fire, electric shock, or injury to persons.
6. To reduce risk of damage to electric plug and cord, pull by plug rather than cord when disconnecting charger.
7. Make sure cord is located so that it will not be stepped on, tripped over, or otherwise subjected to damage or stress.
8. An extension cord should not be used unless absolutely necessary. Use of improper extension cord could result in a risk of fire, electric shock or electrocution.
 - a. Two-wire cords can be used with 2-wire or 3-wire extension cords. Only round jacketed extension cords should be used, and we recommend that they be listed by Underwriters Laboratories (U.L.). If the extension is to be used outside, the cord must be suitable for outdoor use. Any cord marked for outdoor use can also be used for indoor work. The letters "W" or "WA" on the cord jacket indicate that the cord is suitable for outdoor use.
 - b. An extension cord must have adequate wire size (AWG or American Wire Gauge) for safety, and to prevent loss of power and overheating. The smaller the gauge number of the wire, the greater the capacity of the cable; that is, 16 gauge has more capacity than 18 gauge. When using more than one extension to make up the total length, be sure each extension contains at least the minimum wire size.

CHART FOR MINIMUM WIRE SIZE (AWG) OF EXTENSION CORDS NAMEPLATE RATING – 0 – 10.0

Total Extension Cord Length (ft)	25	50	75	100	125
Wire Gauge	18	18	16	16	14

9. Use only the supplied charger when charging your tool. The use of any other charger could damage the tool or create a hazardous condition.

10. Use only one charger when charging.
11. Do not attempt to open the charger. There are no customer serviceable parts inside. Return to any authorized Black & Decker service center.
12. DO NOT incinerate the tool or battery even if they are severely damaged or completely worn out. The batteries can explode in a fire.
13. A small leakage of liquid from the battery cells may occur under extreme usage, charging or temperature conditions. This does not indicate a failure. However, if the outer seal is broken and this leakage gets on your skin:
 - a. Wash quickly with soap and water.
 - b. Neutralize with a mild acid such as lemon juice or vinegar.
 - c. If the battery liquid gets in your eyes, flush them with clean water for a minimum of 10 minutes and seek immediate medical attention. **MEDICAL NOTE:** The liquid is a 25-35% solution of potassium hydroxide.

Charging the Battery

THE BATTERY IS NOT FULLY CHARGED AT THE FACTORY. BEFORE ATTEMPTING TO CHARGE THE BATTERY, THOROUGHLY READ ALL OF THE SAFETY INSTRUCTIONS. The charger is designed to use standard household 230 volt 50 Hz power.

1. Plug the charger into any standard 230 Volt 50 Hz electrical outlet. **NOTE: Do not charge by means of an engine generator or DC power source. Use only 230 V AC.**
2. Slide the charger onto the battery as shown in **figure 1** and let the battery charge initially for 2 hours. After the initial charge, under normal usage, your battery should be fully charged in approx. 1 hour
3. Unplug charger, and remove the battery.

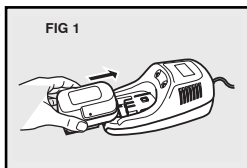

Important Charging Notes

1. After normal usage, your battery should be fully charged in 1 hours. If the battery is run-down completely, it may take up to 2 hours to become fully charged. Your battery was sent from the factory in an uncharged condition. Before attempting to use it, it must be charged for at least 2 hours.
2. DO NOT charge the battery in an air temperature below 40°F (4,5 °C) or above 105°F.(40,5 °C) This is important and will prevent serious damage to the battery. Longest life and best performance can be obtained if battery is charged when air temperature is about 75°F.(24°C).
3. While charging, the charger may hum and become warm to touch. This is a normal condition and does not indicate a problem.
4. If the battery does not charge properly—(1) Check current at receptacle by plugging in a lamp or other appliance. (2) Check to see if receptacle is connected to a light switch which turns power off when you turn out the lights. (3) Move charger and battery to a surrounding air temperature of 40°F (4,5 °C) to 105°F.(40,5 °C) (4) If the receptacle and temperature are OK, and you do not get proper charging, take or send the battery and charger to your local Black & Decker service center. See Tools Electric in yellow pages.
5. The battery should be recharged when it fails to produce sufficient power on jobs which were easily done previously. DO NOT CONTINUE using product with its battery pack in a depleted condition.
6. To prolong battery life, avoid leaving the battery on charge for extended periods of time (over 30 days without use). Although overcharging is not a safety concern, it can significantly reduce overall battery pack life.
7. The battery will reach optimum performance after being cycled 5 times during normal usage. There is no need to run the batteries down completely before recharging. Normal usage is the best method of discharging and recharging the batteries

Pole Saw Names and Terms

- **Chain Brake** - A device used to stop the Pole Saw.
- **Drive Sprocket or Sprocket** - The toothed part that drives the saw chain.
- **Guide Bar** - A solid railed structure that supports and guides the saw chain.
- **Guide Bar Scabbard** - Enclosure fitted over guide bar to prevent tooth contact when saw is not in use.
- **Kickback** - The backward or upward motion, or both of the guide bar occurring when the saw chain near the nose of the top area of the guide bar contacts any object such as a log or branch, or when the wood closes in and pinches the saw chain in the cut.
- **Low-Kickback Chain** - A chain that complies with the kickback performance requirements of ANSI B175.1-1991 (when tested on a representative sample of chain saws).
- **Reduced Kickback Guide Bar** - A guide bar which has been demonstrated to reduce kickback significantly.
- **Replacement Saw Chain** - A chain that complies with kickback performance requirements of ANSI B175.1-1991 when tested with specific chain saws. It may not meet the ANSI performance requirements when used with other saws.
- **Saw Chain** - A loop of chain having cutting teeth, that cut the wood, and that is driven by the motor and is supported by the guide bar.
- **Spiked Bumper (Spike)** - The pointed tooth or teeth for use when pruning to pivot the saw and maintain position while sawing.
- **Switch** - A device that when operated will complete or interrupt an electrical power circuit to the motor of the chain saw.
- **Switch Lockout** - A movable stop that prevents the unintentional operation of the switch until manually actuated.
- **Trimming (Pruning)** - Process of cutting limbs from a tree.
- **Undercut** - An upward cut from underside of a log or limb. This is done while in normal cutting position and cutting with top of guide bar.

Features

Before using your Pole Saw familiarize yourself with all operating and safety features.

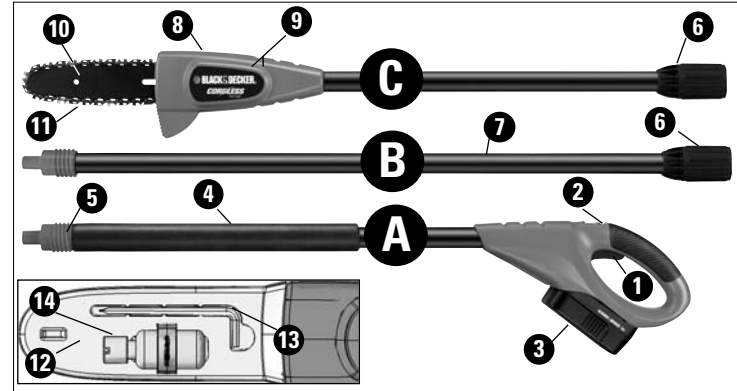

- A. Handle Module
- B. Center Extension Pole
- C. Saw Head Module
- 1. Trigger Switch
- 2. Lock Button
- 3. Battery
- 4. Foam Gripper
- 5. Threaded Pole
- 6. Threaded Sleeve

- 7. Center Extension Pole
- 8. Sprocket Cover (other side)
- 9. Allen Head Screws (other side)
- 10. Guide Bar
- 11. Saw Chain
- 12. Scabbard
- 13. Allen Wrench
- 14. Oil Bottle

Preparing Your Pole Trimmer for Use

⚠ **WARNING:** Read and understand all instructions. Failure to follow all instructions listed below may result in electric shock, fire and/or serious personal injury.

Installing and Removing Saw Chain

⚠ **WARNING:** Sharp moving blade. To prevent accidental operation, insure that battery is disconnected from the handle before performing the following operations. Failure to do this could result in serious personal injury.

⚠ **CAUTION:** Sharp moving blade. Always wear protective gloves when installing or removing the chain. The chain is sharp and can cut you when it is not running.

- Place the saw on a firm surface. Rotate the two allen head screws counterclockwise with the wrench provided as shown in **figure 2**.
- Remove sprocket cover, bar clamp, and allen head screws.
- To remove the chain, rotate the screw in the front of the housing using the flat screwdriver end of the wrench as shown in **figure 3**. Turning the screw counterclockwise allows the guide bar to recede and reduces the tension on the chain so that it may be removed.
- Lift the worn chain out of the groove in the guide bar.
- Flip guide bar over.
- To replace the chain, check to make sure that the slot in the guide bar is over the two location pins shown in **figure 3A** and that the hole below the slot is located over the adjustment pin.

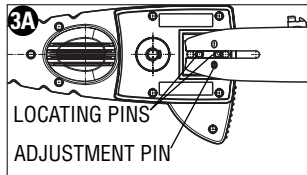
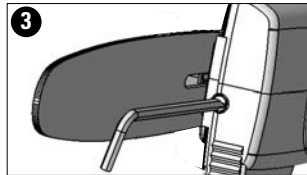
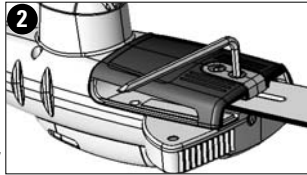

- Place new chain in groove of guide bar and around sprocket. Make sure saw teeth are facing correct direction by matching arrow on chain with graphic on housing shown here.
- Rotate the screw in the front of the housing clockwise to increase the chain tension as in Figure 3.
- Replace sprocket cover, bar clamp, and allen head screws.
- Follow instructions for adjusting the chain tension.



Adjusting Chain Tension

- With the saw still on a firm surface check the chain tension. The tension is correct when the chain snaps back after being pulled 1/8" (3mm) away from the middle finger and thumb as shown in **figure 4**. There should be no "sag" between the guide bar and the chain on the underside as shown in **figure 5**.
- To adjust saw chain tension, loosen allen head screws
- Rotate the screw in the front of the housing using the flat screwdriver end of the wrench as shown in **figure 3**.
- Do not over-tension the chain as this will lead to excessive wear and will reduce the life of the bar and chain. Overtensioning also reduces the amount of cuts you will get per battery charge.
- Once chain tension is correct, tighten allen head screws to clamp bar.
- When the chain is new check the tension frequently (after disconnecting battery) during the first 2 hours of use as a new chain stretches slightly.

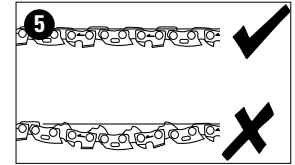
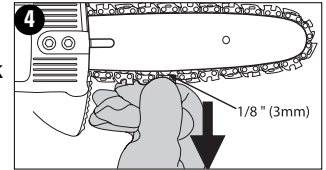

Chain Oiling

- A high quality bar and chain oil or SAE30 weight motor oil should be used for chain and bar lubrication. The use of a vegetable based bar and chain oil is recommended when pruning trees. Mineral oil is not recommended because it may harm trees. Never use waste oil or very thick oil. These may damage your chain saw.
- Lubricate the whole chain evenly before each use as shown in **figure 6**. Also lubricate the chain whenever replacing a fully discharged battery with a fully charged one.

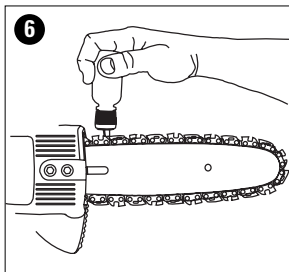

Transporting Pole Saw

- Always remove the battery pack from the handle (**figure 7**) and cover the chain with the scabbard (**figure 8**) when transporting the Pole Saw. See page 5 for additional information on transporting the battery.

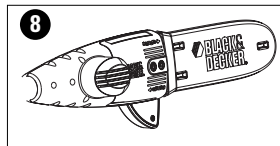

Assembly

Joining Saw Head Module to 18V Handle Module

⚠ WARNING: Sharp moving blade. To prevent accidental operation, insure that battery is disconnected from the handle and that the protective scabbard is in place on the chain before performing the following operations. Failure to do this could result in serious personal injury.

The three modules which make up the 18V Pole Saw are keyed to insure correct assembly. If a module does not smoothly attach to another do not force fit.

Combining the handle module (A) to the saw head module (C) creates a pole saw that is approximately 6 foot in length as shown in **figure 9**.

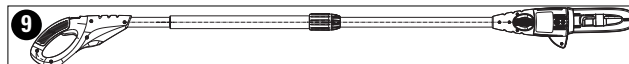

To attach the handle module to the saw head module:

1. Align the **groove** on the **outside** of the coupling end of the handle module (A) with the **tongue** on the **inside** of the coupling end of the saw head module (C). **See figure 10**. Push the two sections completely together.
2. Slide the threaded sleeve (6) **figure 11** on the saw head module down as far as possible and rotate the sleeve clockwise until it stops and completely covers the orange threads as shown in **figure 12**.

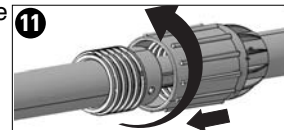
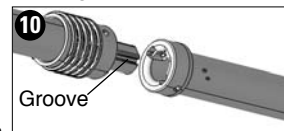

⚠ WARNING: Always check to make sure that the sleeve is completely threaded on and that the orange threads are no longer visible. Not threading the sleeve completely on could result in the modules becoming disconnected creating a hazardous condition. Periodically check the connections to insure that no orange threads are visible.

Joining Center Extension to Saw Head Module and Handle Module

Adding the extension (B) to the handle module (A) and saw head module (C) creates a Pole Saw that is approximately 9 foot in length as shown in **figure 13**.

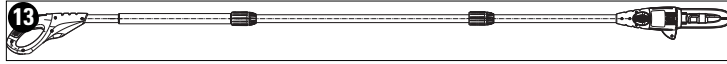

To attach the middle module to the handle module and saw head module:

1. Align the **groove** on the **outside** of the coupling end of the handle module (A) with the **tongue** on the **inside** of the coupling end of the center extension (B). **See figure 14**. Push the two sections completely together.
2. Slide the threaded sleeve (6) (**figure 15**) on the center extension down as far as possible and rotate the sleeve clockwise until it stops and completely covers the orange threads as shown in **figure 16**.
3. Repeat steps 1 and 2 above to attach the saw head module to the center extension.

⚠ WARNING: Always check to make sure that the sleeve is completely threaded on and that the orange threads are no longer visible. Not threading the sleeve completely on could result in the modules becoming disconnected creating a hazardous condition. Periodically check the connections to insure that no orange threads are visible.

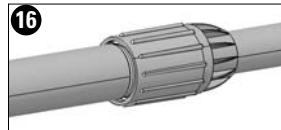
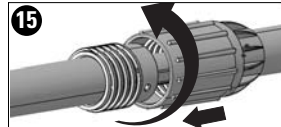
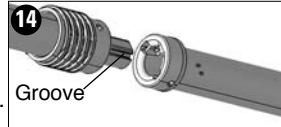

Disassembly

Detaching Saw Head Module

⚠ WARNING: Sharp moving blade. To prevent accidental operation, insure that battery is disconnected from the handle and that the protective scabbard is in place on the chain before performing the following operations. Failure to do this could result in serious personal injury.

When detaching the modules, whether it is in the two module or three module mode, always detach the saw head module first. To do this, rest the handle module on the ground and grasp the center of the saw head module with one hand **figure 17**. Use your other hand to loosen the threaded sleeve **figure 18** and then pull the two halves apart.

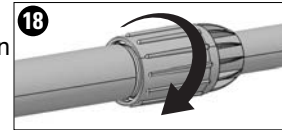
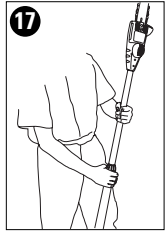

Repeat this process if the center extension was attached.

Operating the Pole Saw

⚠ WARNING: Read and understand all instructions. Failure to follow all instructions listed below may result in electric shock, fire and/or serious personal injury.

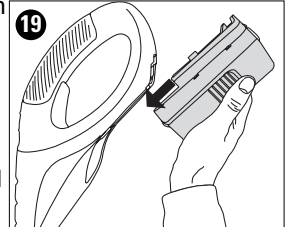

Connecting the Battery

Place the battery in the tool as shown in **figure 19** and be certain that it is inserted fully into the tool cavity until it "clicks" into place. To remove the battery from the tool, press down on the release button on the back of the battery (**figure 20**) and slide out.

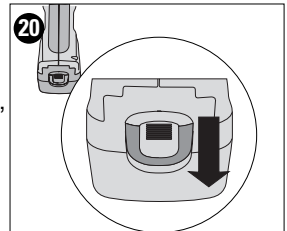

Switch

Always be sure of your footing and grip the Pole Saw firmly with both hands with the thumb and fingers encircling the handle. To turn the tool ON pull the lock button (1) back with your thumb and then squeeze the trigger (2) with your fingers as shown in **figure 21**. (Once the tool is running you can release the lock button.) To turn the tool OFF, release the trigger.

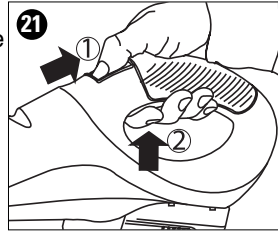

Auto-Stop Chain Braking System

Your chain saw is fitted with an auto-stop chain braking system which will stop the chain quickly each time you release the rear trigger, or if kickback should occur. This system should be tested before every use.

Operating Position

Always Wear:

Head Protection

Eye Protection

Work Gloves

Long Pants

Steel Toed Shoes

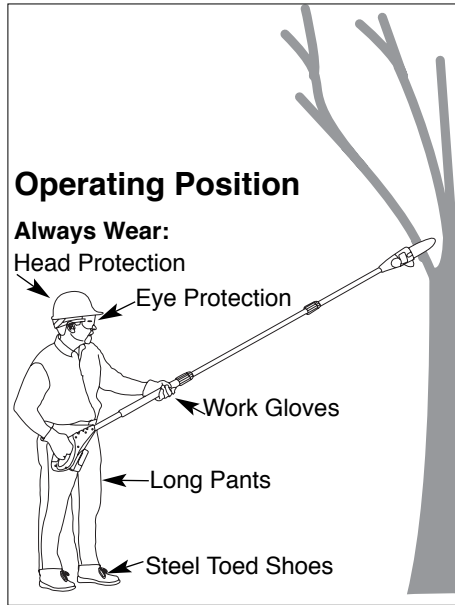

Pole Saw Trimming / Pruning

⚠ Warnings:

- **Never stand directly under the limb you are cutting.** Always position yourself out of the path of falling debris.
- **Always wear head, eye, foot and body protection.** Wearing body protection helps reduce the risk of injury when operating this unit.
- **Never stand on a ladder or other unstable support while using the Pole Saw.** Always avoid any position which can cause you to lose your balance and cause severe injury.



- **Keep other persons at least 50 feet (15m) from the work area.** Distractions can cause you to lose control.
- **Electrocution Hazard. To prevent shock, do not operate within 50 feet (15m) of overhead electrical lines.** Always check surrounding area for hidden electrical lines.
- **Do not extend Pole Saw switch handle above shoulder height.**



Pruning With the Pole Saw

⚠ **Warning:** When pruning trees:

- **Guard Against Kickback** which can result in **severe injury or death**. See “KICKBACK”, page 3 to avoid the risk of kickback.
- **Do not overreach. Make sure your footing is firm.** Keep feet apart. Divide your weight evenly on both feet.
- **Use both hands to grip Pole Saw as shown in figure 22.** Use a firm grip. Thumbs and fingers must wrap around Pole Saw handle and pole. Keep fingers away from sawdust exhaust chute shown in figure 22a.
- **Never operate while in a tree, in any awkward position or on a ladder or other unstable surface.** You may lose control of Pole Saw causing severe injury.

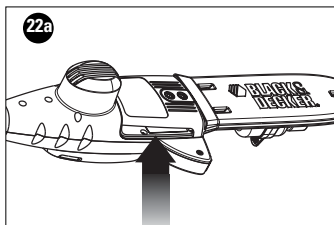
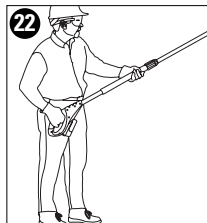

Follow directions below to trim a tree.

1. Make sure Pole Saw is running at full speed before making a cut. When starting a cut, place moving chain against limb. Hold Pole Saw firmly in place to avoid possible bouncing or skating (sideways movement) of Pole Saw.
2. Guide Pole Saw using light pressure. Make first cut six inches from tree trunk on underside of limb. Use top of guide bar to make this cut. Cut 1/3 through diameter of limb. Then make the finish cut from the top as shown in **figure 23**.

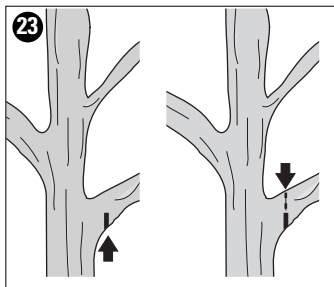

If you try to cut off thick branches from the bottom, the branch may close in and pinch the saw chain in the cut. If you try to cut off thick branches from the top, without a shallow undercut, the branch may splinter **figure 24**.

Do not force Pole Saw. The motor will overload and can burn out. It will do the job better and safer at the rate for which it was intended.

3. Remove Pole Saw from cut while it is running at full speed. Stop Pole Saw by releasing trigger. Make sure chain has stopped before setting Pole Saw down.

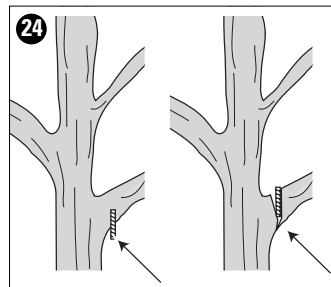

Saw chain sharpness

The cutters will dull immediately if they touch the ground or a nail while cutting.

Saw chain tension

This should be done regularly. Refer to page 8 “Adjusting Chain Tension”.

Pole Saw Maintenance Section

Regular maintenance ensures a long effective life for the tool.

After every 10 minutes of use be sure to remove the battery (be aware the chain and bar can be hot!) check the bar and chain for correct tension and lubricate per pole saw instruction manual.

Use only mild soap and damp cloth to clean the tool. Never let any liquid get inside the tool; never immerse any part of the tool into a liquid.

IMPORTANT: To assure product SAFETY and RELIABILITY, repairs, maintenance and adjustment should be performed by authorized service centers or other qualified service organizations, always using identical replacement parts.

Accessories

Replacement chain and bar are available from your nearest Black & Decker service center.

Replacement chain # 623382-00

Replacement bar # 623381-00

The use of accessories not recommended in this manual may be hazardous.

Troubleshooting Section

If your Pole Saw does not operate correctly check the following:

Problem	Possible Cause	Possible Solution
<ul style="list-style-type: none">• Tool will not start.	<ul style="list-style-type: none">• Battery not installed properly.• Battery not charged.• Lock-out button not actuated.• Pole connections not properly tightened.	<ul style="list-style-type: none">• Check battery installation.• Check battery charging requirements.• Pull back on lock button/actuate trigger.• Refer to instruction manual for pole connections.
<ul style="list-style-type: none">• Unit will not charge.	<ul style="list-style-type: none">• Battery not inserted into charger.	<ul style="list-style-type: none">• Insert battery into charger until red LED appears. Charge up to 2 hours if battery totally drained.
<ul style="list-style-type: none">• Bar / chain overheated.	<ul style="list-style-type: none">• Chain too tight.• Lubrication needed.	<ul style="list-style-type: none">• Refer to section on adjusting chain tension.• Refer to sections for chain oiling application.
<ul style="list-style-type: none">• Chain is loose.	<ul style="list-style-type: none">• Chain tension set incorrectly.	<ul style="list-style-type: none">• Refer to section for chain tensioning.
<ul style="list-style-type: none">• Poor cut quality.	<ul style="list-style-type: none">• Chain tension set incorrectly.• Chain needs replacement.	<ul style="list-style-type: none">• Refer to section on adjusting chain tension. Note: Excessive tension leads to excessive wear and reduction in life of bar & chain. Lubricate after every 10 minutes of use. Refer to section for installation of chain.

Troubleshooting Section Con't.

Problem

- Unit runs but does not cut.

Possible Cause

- Chain installed backwards.

Possible Solution

- Refer to sections for installing and removing chain.

SERVICE INFORMATION

All Black & Decker Service Centers are staffed with trained personnel to provide customers with efficient and reliable power tool service. Whether you need technical advice, repair, or genuine factory replacement parts, contact the Black & Decker location nearest you. To find your local service location, refer to the yellow page directory under "Tools—Electric" or call:

(AUS) 1800-654-155 or (NZ) 09 579 7500
or visit www.blackanddecker.com.au

See 'Tools-Electric'
– Yellow Pages –
for Service & Sales



GUARANTEE

Black & Decker is confident of the quality of its products and offers an outstanding guarantee. This guarantee statement is in addition to and in no way prejudices your statutory rights. Your attention is drawn to the provisions of the Consumer Guarantee Act 1993 (New Zealand only), Trade Practices Act 1974 and State legislation (Australia only), which confers rights upon consumers. If a Black & Decker product becomes defective due to faulty materials, workmanship or lack of conformity, within 48 months from the date of purchase, Black & Decker guarantees to replace defective parts, repair products subjected to fair wear and tear or replace such products to ensure minimum inconvenience to the customer unless: The product has been used for trade, professional or hire purposes; The product has been subjected to miss use or neglect; The product has sustained damage through foreign objects, substances or accidents; Repairs have been attempted by persons other than To claim on the guarantee, you will need to submit proof of purchase to the seller or an authorised repair agent. You can check the location of your nearest authorised repair agent by contacting your local Black & Decker office at the address indicated in this manual.

Australia

Black & Decker (Australia) Pty. Ltd. 20
Fletcher Road, Mooroolbark,
Victoria, 3138
Tel. 03-8720 5100
Fax 03-9727 5940

New Zealand

Black & Decker 81 Hugo Johnston Drive
Penrose, Auckland, New Zealand
Tel. 09 579 7600
Fax 09 579 8200

