

INSTRUCTION MANUAL

DEWALT®

D28116-XE, D28117-XE, D28133-XE, D28136-XE, D28137-XE

HEAVY-DUTY SMALL ANGLE GRINDERS



Definitions: Safety Guidelines

The definitions below describe the level of severity for each signal word. Please read the manual and pay attention to these symbols.

⚠DANGER: Indicates an imminently hazardous situation which, if not avoided, **will** result in **death or serious injury**.

⚠WARNING: Indicates a potentially hazardous situation which, if not avoided, **could** result in **death or serious injury**.

⚠CAUTION: Indicates a potentially hazardous situation which, if not avoided, **may** result in **minor or moderate injury**.

NOTICE: Used without the safety alert symbol indicates a potentially hazardous situation which, if not avoided, **may** result in **property damage**.

IF YOU HAVE ANY QUESTIONS OR COMMENTS ABOUT THIS OR ANY DeWALT TOOL, CALL US AT: **1800 654 155** (Aust) or **0800 339258** (NZ).

SAFETY INSTRUCTIONS FOR POWER TOOLS

When using power tools, always observe the safety regulations applicable in your country to reduce the risk of fire, electric shock and personal injury. Read the following safety instructions before attempting to operate this product. Keep these instructions in a safe place.



WARNING: To reduce the risk of injury, read the instruction manual.

GENERAL SAFETY WARNINGS



WARNING! Read all safety warnings and all instructions. Failure to follow the warnings and instructions may result in electric shock, fire and/or serious injury.

The term “power tool” in the warnings refers to your mains-operated (corded) power tool or battery-operated (cordless) power tool.

SAVE THESE INSTRUCTIONS

1) WORK AREA SAFETY

- a) **Keep work area clean and well lit.** Cluttered or dark areas invite accidents.
- b) **Do not operate power tools in explosive atmospheres, such as in the presence of flammable liquids, gases or dust.** Power tools create sparks which may ignite the dust or fumes.
- c) **Keep children and bystanders away while operating a power tool.** Distractions can cause you to lose control.

2) ELECTRICAL SAFETY

- a) **Power tool plugs must match the outlet. Never modify the plug in any way. Do not use any adapter plugs with earthed (grounded) power tools.** Unmodified plugs and matching outlets will reduce risk of electric shock.
- b) **Avoid body contact with earthed or grounded surfaces such as pipes, radiators, ranges and refrigerators.** There is an increased risk of electric shock if your body is earthed or grounded.
- c) **Do not expose power tools to rain or wet conditions.** Water entering a power tool will increase the risk of electric shock.
- d) **Do not abuse the cord. Never use the cord for carrying, pulling or unplugging the power tool. Keep cord away from heat, oil, sharp edges or moving parts.** Damaged or entangled cords increase the risk of electric shock.
- e) **When operating a power tool outdoors, use an extension cord suitable for outdoor use.** Use of a cord suitable for outdoor use reduces the risk of electric shock.

3) PERSONAL SAFETY

- a) **Stay alert, watch what you are doing and use common sense when operating a power tool. Do not use a power tool while you are tired or under the influence of drugs, alcohol or medication.** A moment of inattention while operating power tools may result in serious personal injury.
- b) **Use safety equipment. Always wear eye protection.** Protective equipment such as dust mask, non-skid safety shoes, hard hat, or hearing protection used for appropriate conditions will reduce personal injuries.
- c) **Prevent unintentional starting. Ensure the switch is in the off position before plugging in.** Carrying power tools with your finger on the switch or plugging in power tools that have the switch on invites accidents.

- d) **Remove any adjusting key or wrench before turning the power tool on.** A wrench or a key left attached to a rotating part of the power tool may result in personal injury.
- e) **Do not overreach. Keep proper footing and balance at all times.** This enables better control of the power tool in unexpected situations.
- f) **Dress properly. Do not wear loose clothing or jewellery. Keep your hair, clothing and gloves away from moving parts.** Loose clothes, jewellery or long hair can be caught in moving parts.
- g) **If devices are provided for the connection of dust extraction and collection facilities, ensure these are connected and properly used.** Use of dust collection can reduce dust-related hazards.

4) POWER TOOL USE AND CARE

- a) **Do not force the power tool. Use the correct power tool for your application.** The correct power tool will do the job better and safer at the rate for which it was designed.
- b) **Do not use the power tool if the switch does not turn it on and off.** Any power tool that cannot be controlled with the switch is dangerous and must be repaired.
- c) **Disconnect the plug from the power source and/or the battery pack from the power tool before making any adjustments, changing accessories, or storing power tools.** Such preventive safety measures reduce the risk of starting the power tool accidentally.
- d) **Store idle power tools out of the reach of children and do not allow persons unfamiliar with the power tool or these instructions to operate the power tool.** Power tools are dangerous in the hands of untrained users.
- e) **Maintain power tools. Check for misalignment or binding of moving parts, breakage of parts and any other condition that may affect the power tool's operation. If damaged, have the power tool repaired before use.** Many accidents are caused by poorly maintained power tools.
- f) **Keep cutting tools sharp and clean.** Properly maintained cutting tools with sharp cutting edges are less likely to bind and are easier to control.
- g) **Use the power tool, accessories and tool bits etc., in accordance with these instructions and in the manner intended for the particular type of power tool, taking into account the working conditions and the work to be**

performed. Use of the power tool for operations different from those intended could result in a hazardous situation..

5) SERVICE

- a) **Have your power tool serviced by a qualified repair person using only identical replacement parts.** This will ensure that the safety of the power tool is maintained.

Electrical Safety

The electric motor has been designed for one voltage only. Always check that the power supply corresponds to the voltage on the rating plate. 240 V AC means your tool will operate on alternating current. As little as 10% lower voltage can cause loss of power and can result in overheating. All DeWALT tools are factory tested; if this tool does not operate, check the power supply. Your DeWALT tool is double insulated, therefore no earth wire is required.

- **Young children and the infirm.** This appliance is not intended for use by young children or infirm persons without supervision. Young children should be supervised to ensure that they do not play with this appliance.
- **Replacement of the supply cord.** If the supply cord is damaged, it must be replaced by the manufacturer or an authorised DeWALT Service Centre in order to avoid a hazard.

Extension Cords

⚠ CAUTION: Use only extension cords that are approved by the country's Electrical Authority. Before using extension cords, inspect them for loose or exposed wires, damaged insulation and defective fittings. Replace the cord if necessary.

MINIMUM GAUGE FOR CORD SETS

For Cable length (m):	7.5	15	25	30	45	60
Use Cable with minimum rating (Amperes)						
Tool Amperes						
0 - 3.4	7.5	7.5	7.5	7.5	7.5	7.5
3.5 - 5.0	7.5	7.5	7.5	7.5	10	15
5.1 - 7.0	10	10	10	10	15	15
7.1 - 12.0	15	15	15	15	20	20
12.1 - 20.0	20	20	20	20	25	–

Additional Safety Instructions

- Check that the grinding wheel backing flange has a yellow rubber ring (S) installed, see Figure 1. Replace rubber ring if missing, damaged or worn. See page 6 for details regarding proper accessory installation.

⚠ WARNING: The grinding wheel or accessory may loosen during coast-down of the tool when shut off if rubber ring is missing or damaged. If grinding wheel or accessory loosens, it may dismount from the machine and may cause serious personal injury.

- **Always use proper guard with grinding wheel.** A guard protects operator from broken wheel fragments and wheel contact.
- **Accessories must be rated for at least the speed recommended on the tool warning label.** Wheels and other accessories running over rated speed can fly apart and cause injury. Accessory ratings must be above listed minimum wheel speed as shown on tool nameplate.
- **Hold tool by insulated gripping surfaces when performing an operation where the cutting tool may contact hidden wiring or its own cord.** Contact with a "live" wire will make exposed metal parts of the tool "live" and shock the operator.
- **Do not use Type 11 (flaring cup) wheels on this tool.** Using inappropriate accessories can result in injury.
- **ALWAYS WEAR EYE PROTECTION WHEN USING THIS TOOL.**
- **Use of accessories not specified in this manual is not recommended and may be hazardous.** Use of power boosters that would cause the tool to be driven at speeds greater than its rated speed constitutes misuse.
- **Do not use circular saw blades or any other toothed blades with this tool.** Serious injury may result.
- **When starting the tool with a new or replacement wheel, or a new or replacement wire brush installed, hold the tool in a well protected area and let it run for one minute.** If the wheel has an undetected crack or flaw, it should burst in less than one minute. If the wire brush has loose wires, they will be detected. Never start the tool with a person in line with the wheel. This includes the operator.

- **Avoid bouncing the wheel or giving it rough treatment.** If this occurs, stop the tool and inspect the wheel for cracks or flaws.
- **Direct sparks away from operator, bystanders or flammable materials.** Sparks may be produced while cutting and/or grinding. Sparks may cause burns or start fires.
- **Always use side handle. Tighten the handle securely.** The side handle should always be used to maintain control of the tool at all times.
- **Never cut into area that may contain electrical wiring or piping.** Serious injury may result.
- **Clean out your tool often, especially after heavy use.** Dust and grit containing metal particles often accumulate on interior surfaces and could create an electric shock hazard.
- **Do not operate this tool for long periods of time.** Vibration caused by the operating action of this tool may cause permanent injury to fingers, hands, and arms. Use gloves to provide extra cushion, take frequent rest periods, and limit daily time of use.
- **Direct the Dust Ejection System™ away from operator and coworkers.** Serious injury may result (Fig. 1, F).

Causes and Operator Prevention of Kickback

- Kickback is a sudden reaction to a pinched, bound or misaligned wheel, wire brush or flap disc causing an uncontrolled cut-off tool to lift up and out of the workpiece toward the operator.
- When the wheel is pinched or bound tightly by the workpiece, the wheel stalls and the motor reaction drives the unit rapidly back toward or away from the operator.
- Kickback is the result of tool misuse and/or incorrect operating procedures or conditions and can be avoided by taking proper precautions as given below:
- **Maintain a firm grip with both hands on the unit and position your body and arm to allow you to resist kickback forces.** Kickback forces can be controlled by the operator, if proper precautions are taken.
- **When wheel is binding, or when interrupting a cut for any reason, release the trigger and hold the unit motionless in the material until the wheel comes to a complete stop. Never attempt to remove the unit from the work or pull the unit**

backward while the wheel is in motion or kickback may occur. Investigate and take corrective actions to eliminate the cause of wheel binding.

- **When restarting a cut-off accessory in the workpiece, check that the wheel is not engaged into the material.** If wheel is binding, it may walk up or kickback from the workpiece as the tool is restarted.
- **Support large panels to minimize the risk of wheel pinching and kickback.** Large panels tend to sag under their own weight. Support must be placed under the panel on both sides, near the line of cut and near the edge of the panel.

⚠ WARNING: ALWAYS use safety glasses. Everyday eyeglasses are NOT safety glasses. Also use face or dust mask if cutting operation is dusty. ALWAYS WEAR CERTIFIED SAFETY EQUIPMENT:

- ANSI Z87.1 eye protection (CAN/CSA Z94.3),
- ANSI S12.6 (S3.19) hearing protection,
- NIOSH/OSHA/MSHA respiratory protection.

⚠ WARNING: Some dust created by power sanding, sawing, grinding, drilling, and other construction activities contains chemicals known to cause cancer, birth defects or other reproductive harm. Some examples of these chemicals are:

- lead from lead-based paints,
- crystalline silica from bricks and cement and other masonry products, and
- arsenic and chromium from chemically-treated lumber (CCA).

Your risk from these exposures varies, depending on how often you do this type of work. To reduce your exposure to these chemicals: work in a well ventilated area, and work with approved safety equipment, such as those dust masks that are specially designed to filter out microscopic particles.

- **Avoid prolonged contact with dust from power sanding, sawing, grinding, drilling, and other construction activities. Wear protective clothing and wash exposed areas with soap and water.** Allowing dust to get into your mouth, eyes, or lay on the skin may promote absorption of harmful chemicals.

⚠ WARNING: Use of this tool can generate and/or disburse dust, which may cause serious and permanent respiratory or other injury. Always use NIOSH/OSHA approved respiratory protection appropriate for the dust exposure. Direct particles away from face and body.

⚠ WARNING: ALWAYS wear proper personal hearing protection that conforms to ANSI S12.6 (S3.19) during use. Under some conditions and duration of use, noise from this product may contribute to hearing loss.

⚠ WARNING Use extra care when working into a corner because a sudden, sharp movement of the grinder may be experienced when the wheel or other accessory contacts a secondary surface or a surface edge.

⚠ WARNING: We recommend the use of a residual current device with a residual current rating of 30mA or less.

- The label on your tool may include the following symbols. The symbols and their definitions are as follows:

V	volts	A	amperes
Hz	hertz	W	watts
min	minutes	~	alternating current
==	direct current	⎓	alternating or direct current
Ⓛ	Class I Construction (grounded)	no	no load speed
Ⓜ	Class II Construction (double insulated)	Ⓧ	earthing terminal
.../min	per minute	⚠	safety alert symbol
IPM	impacts per minute	RPM	revolutions per minute
		BPM	beats per minute

COMPONENTS (FIG. 1)

- On/off switch
- Spindle lock
- Guard
- Side handle (not shown)
- Electronic variable speed control
- Dust ejection outlet

Anti-vibration Side Handle

The anti-vibration side handle(D) offers added comfort by absorbing the vibrations caused by the tool.

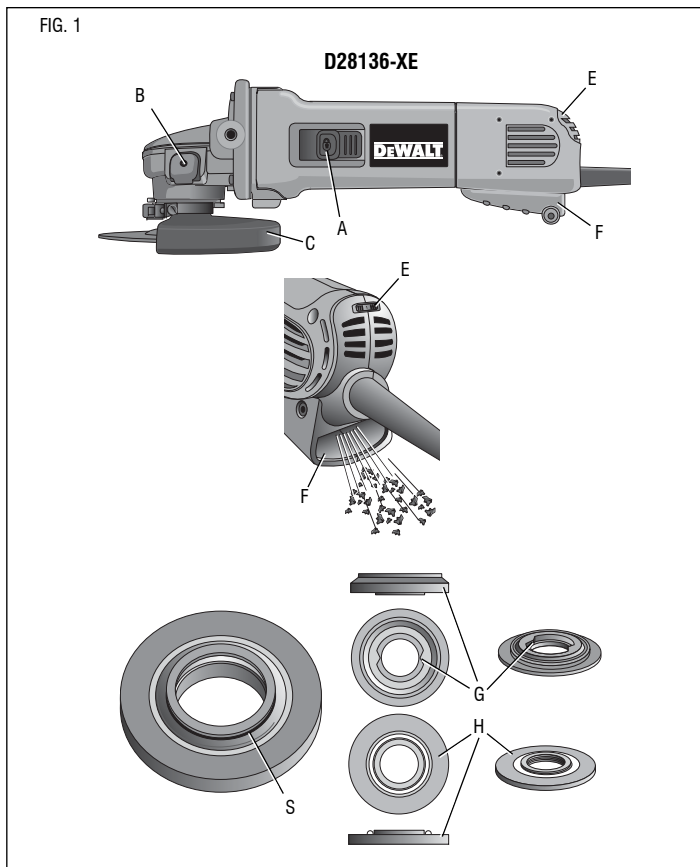

Keyless Guard

The keyless guard (C) allows for quick adjustment during the application to enhance application versatility.

Dust Ejection System

The dust ejection system prevents dust pile-up around the guard and motor inlet, and minimises the amount of dust entering the motor housing.

Soft Start Feature

D28116, D28117, D28133, D28136, D28137

The soft start feature allows a slow speed build-up to avoid an initial jerk when starting. This feature is particularly useful when working in confined spaces.

Electronic Variable Speed Control

D28116, D28117, D28136, D28137

The electronic variable speed control (E) offers added tool control and enables the tool to be used at optimum conditions to suit the accessory and material.

Autobalance Feature

D28117, D28137

The auto balance feature continuously adjusts the balance to reduce the vibration of the machine when it is running. This improves user comfort during the operation and is particularly useful when using the machine for long periods of time.

Clutch

The torque limiting clutch reduces the maximum torque reaction transmitted to the operator in case of jamming of a cutting disc. This feature also prevents the gearing and electric motor from stalling. The torque limiting clutch has been factory-set and cannot be adjusted.

No-volt Release Switch

The on/off switch (A) has a no-volt release function. If the power be shut off for some reason, the switch has to be deliberately reactivated.

Overload Protection

The power supply to the motor will be reduced in case of motor overload. The power will return to normal once the tool has cooled down to suitable operating temperature.

ASSEMBLY AND ADJUSTMENTS

Attaching Side Handle

The side handle (D) can be fitted to either side of the gear case in the threaded holes, as shown. Before using the tool, check that the handle is tightened securely.

Accessories

It is important to choose the correct guards, backing pads and flanges to use with grinder accessories. See pages 7–8 for information on choosing the correct accessories.

⚠ WARNING: Accessories must be rated for at least the speed recommended on the tool warning label. Wheels and other accessories running over rated accessory speed may burst and cause injury. Threaded accessories must have a M14x2 hub. Every unthreaded accessory must have a 22 mm (7/8") arbor hole. If it does not, it may have been designed for a circular saw and should not be used. Use only the accessories shown on pages 7–8 of this manual. Accessory ratings must be above listed minimum wheel speed as shown on tool nameplate.

Guard

⚠ WARNING: Turn off and unplug the tool before making any adjustments or removing or installing attachments or accessories. Before reconnecting the tool, depress and release the paddle switch to ensure that the tool is off.

⚠ WARNING: Guards must be used with all grinding wheels, sanding flap discs, wire brushes, and wire wheels. The tool may be used without a guard only when sanding with conventional sanding discs. Some DeWALT models are provided with a guard intended for use with

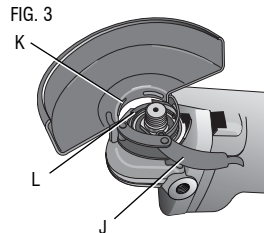
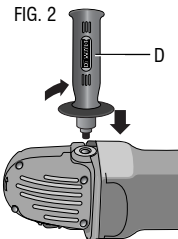

depressed center wheels (Type 27) and hubbed grinding wheels (Type 27). The same guard is designed for use with sanding flap discs (Type 27 and 29) and wire brushes. Grinding and cutting with wheels other than Type 27 and 29 require different accessory guards not included with tool. Mounting instructions for these accessory guards are included in the accessory package.

MOUNTING AND REMOVING GUARD D28116, D28133, D28136

1. Open the guard latch (J). Align the lugs (K) on the guard with the slots (L) on the gear case.
2. Push the guard down until the guard lugs engage and rotate freely in the groove on the gear case hub.
3. With the guard latch open, rotate the guard (C) into the desired working position. The guard body should be positioned between the spindle and the operator to provide maximum operator protection.
4. Close the guard latch to secure the guard on the gear case. You should not be able to rotate the guard by hand when the latch is closed. Do not operate the grinder with a loose guard or the clamp lever in open position.
5. To remove the guard, open the guard latch, rotate the guard so that the arrows are aligned and pull up on the guard.

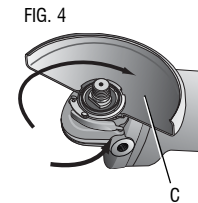

NOTE: The guard is pre-adjusted to the diameter of the gear case hub at the factory. If, after a period of time, the guard becomes loose, tighten the adjusting screw (M) with clamp lever in the closed position.

⚠ CAUTION: If guard cannot be tightened by adjusting clamp, do not use tool and take the tool and guard to a service center to repair or replace the guard.

NOTICE: Do not tighten the adjusting screw with the clamp lever in open position. Undetectable damage to the guard or the mounting hub may result.

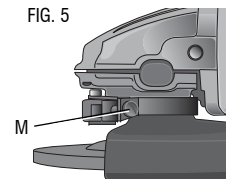

Grinding Wheels

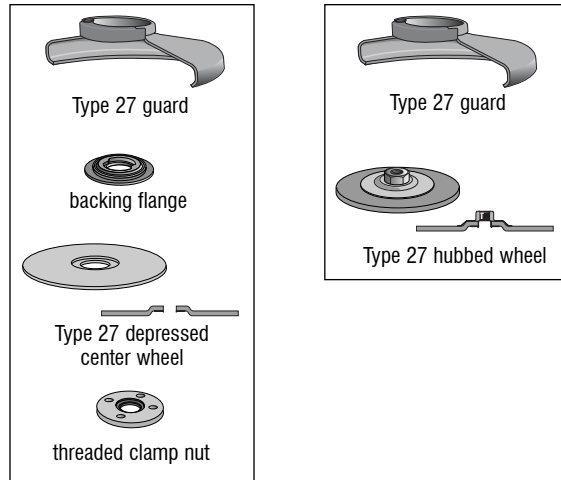

Wire Wheels

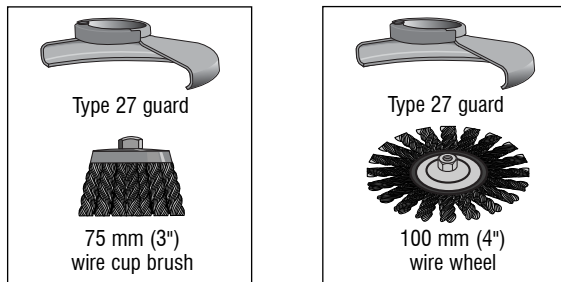

MOUNTING AND REMOVING GUARD D28117, D28137

1. Remove fasteners.
2. Proceed as previously described to slide guard past the spindle.
3. Replace the fasteners.
4. Clamp the guard as previously described.

Fitting and Removing a Grinding or Cutting Disc (fig. 1, 6, 7)

1. Place the tool on a table, guard up.
2. Fit the inner flange (N) correctly onto the spindle (O) (fig. 6).
3. Place the disc (P) on the flange (N). When fitting a disc with a raised center, make sure that the raised centre (Q) is facing the flange (N).
4. Screw the outer flange (R) onto the spindle (O) (fig. 7):
 - the ring on the flange (R) must face towards the disc when fitting a grinding disc (Fig. 7A);
 - the ring on the flange (R) must face away from the disc when fitting a cutting disc (Fig. 7B).
5. Press the spindle lock (B) and rotate the spindle (O) until it locks in position.
6. Tighten the flange (R) with the two-pin spanner supplied.
7. Release the spindle lock.

To remove the disc, loosen the flange (R) with the two-pin spanner.

⚠ WARNING: Do not use a damaged disc.

FIG. 6

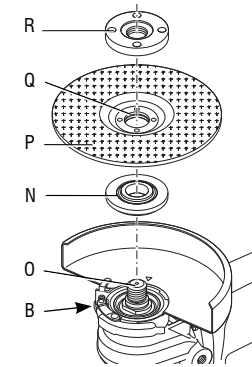
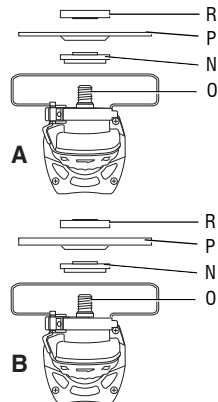
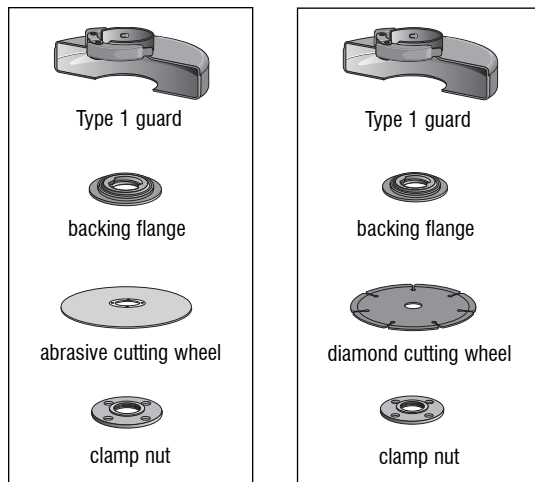

FIG. 7



Cutting Wheels



Sanding Discs

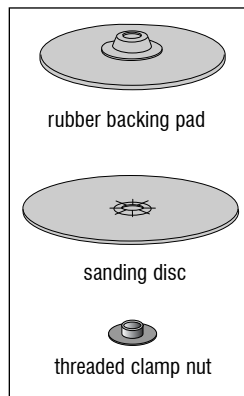

Sanding Flap Discs

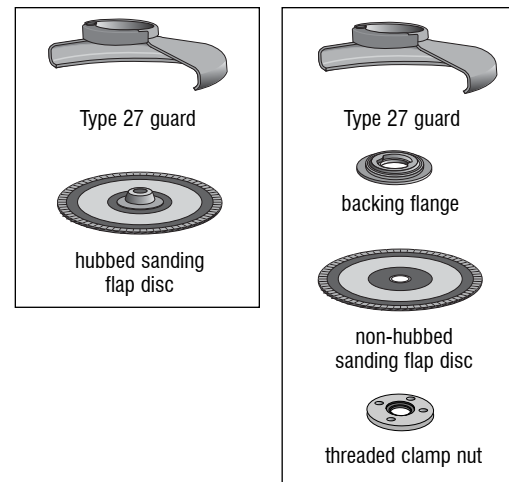

Setting the Electronic Speed Control (fig. 1)

D28116, D28117, D28136, D28137

Turn the dial (E) to the desired level. Turn the dial upwards for higher speed and downwards for lower speed. The required setting is a matter of experience.

E.g.:

- when cutting in soft, brittle materials, set the dial to a low setting;
- when cutting in harder materials, set the dial to a high setting.

OPERATION

⚠ WARNING: Ensure all materials to be ground or cut are secured in place.

⚠ WARNING: Avoid overloading. Should the tool become hot, let it run a few minutes under no load condition. Apply only a gentle pressure to the tool.

⚠ WARNING: Do not exert side pressure on the disc.

Guards and Flanges

It is important to choose the correct guards and flanges to use with the grinder accessories. See pages 7–8 for the correct accessories.

NOTE: Edge grinding and cutting can be performed with Type 27 wheels designed and specified for this purpose.

⚠ WARNING: Accessories must be rated for at least the speed recommended on the tool warning label. Wheels and other accessories running over rated accessory speed may burst and cause injury. Every unthreaded accessory must have a 22 mm (7/8") arbor hole. If it does not, it may have been designed for a circular saw and should not be used. Use only the accessories shown on pages 7–8. Accessory ratings must be above listed minimum wheel speed as shown on tool nameplate.

Switches

⚠ WARNING: Hold the side handle and body of the tool firmly to maintain control of the tool at start up and during use and until the wheel or accessory stops rotating. Make sure the wheel has come to a complete stop before laying the tool down.

⚠ WARNING: Before connecting the tool to a power supply, be sure the switch is in the off position by pressing the rear part of the switch and releasing. Ensure the switch is in the off position as described above after any interruption in power supply to the tool, such as the activation of a ground fault interrupter, throwing of a circuit breaker, accidental unplugging, or power failure. If the switch is locked on when the power is connected, the tool will start unexpectedly.

NOTE: To reduce unexpected tool movement, do not switch the tool on or off while under load conditions. Allow the grinder to run up to full speed before touching the work surface. Lift the tool from the surface before turning the tool off. Allow the tool to stop rotating before putting it down.

To run the tool, press the on/off switch (A).

For continuous operation, press the switch completely forward.

To stop the tool, release the switch.

To stop the tool in continuous operation, press on the back part of the switch.

Spindle Lock

The spindle lock (B) is provided to prevent the spindle from rotating when installing or removing wheels. Operate the spindle lock only when the tool is turned off, unplugged from the power supply, and has come to a complete stop. Do not engage the spindle lock while the tool is operating because damage to the tool will result. To engage the lock, depress the spindle lock button and rotate the spindle until you are unable to rotate the spindle further.

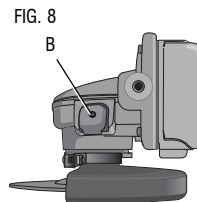

Surface Grinding with Grinding Wheels

1. Allow the tool to reach full speed before touching the tool to the work surface.
2. Apply minimum pressure to the work surface, allowing the tool to operate at high speed. Grinding rate is greatest when the tool operates at high speed.

3. Maintain a 20° to 30° angle between the tool and work surface.

4. Continuously move the tool in a forward and back motion to avoid creating gouges in the work surface.

5. Remove the tool from work surface before turning tool off. Allow the tool to stop rotating before laying it down.

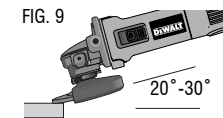

Edge Grinding with Grinding Wheels

⚠ CAUTION: Wheels used for cutting and edge grinding may break if they bend or twist while the tool is being used to do cut-off work or deep grinding. To reduce the risk of serious injury, limit the use of these wheels with a standard Type 27 guard to shallow cutting and notching [less than 13 mm (1/2") in depth]. The open side of the guard must be positioned away from the operator. For deeper cutting with a Type 1 cut-off wheel, use a closed, Type 1 guard. See the chart on page 8 for more information. Type 1 guards are available at extra cost from your local dealer or authorized service center.

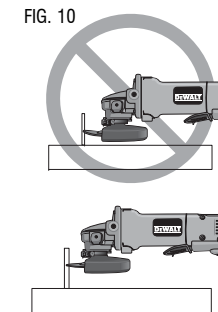

1. Allow the tool to reach full speed before touching the tool to the work surface.
2. Apply minimum pressure to the work surface, allowing the tool to operate at high speed. Grinding rate is greatest when the tool operates at high speed.
3. Position yourself so that the open-underside of the wheel is facing away from you.
4. Once a cut is begun and a notch is established in the workpiece, do not change the angle of the cut. Changing the angle will cause the wheel to bend and may cause wheel breakage. Edge grinding wheels are not designed to withstand side pressures caused by bending.
5. Remove the tool from the work surface before turning the tool off. Allow the tool to stop rotating before laying it down.

⚠ WARNING: Do not use edge grinding/cutting wheels for surface grinding applications because these wheels are not designed for side pressures encountered with surface grinding. Wheel breakage and injury may result.

Mounting and Using Cutting (Type 1) Wheels

Cutting wheels include diamond wheels and abrasive discs. Abrasive cutting wheels for metal and concrete use are available. Diamond blades for concrete cutting can also be used.

⚠ WARNING: A closed, 2-sided cutting wheel guard is not included with this tool but is required when using cutting wheels. Failure to use proper flange and guard can result in injury resulting from wheel breakage and wheel contact. See page 8 for more information.

MOUNTING CLOSED (TYPE 1) GUARD

⚠ WARNING: Turn off and unplug the tool before making any adjustments or removing or installing attachments or accessories. Before reconnecting the tool, turn the switch on and off as previously described to ensure that the tool is off.

1. Open the guard latch (J). Align the lugs (K) on the guard with the slots (L) on the gear case.
2. Push the guard down until the guard lug engages and rotates freely in the groove on the gear case hub.
3. Rotate guard (C) into desired working position. The guard body should be positioned between the spindle and the operator to provide maximum operator protection.
4. Close the guard latch to secure the guard on the gear case cover. You should be unable to rotate the guard by hand when the latch is in closed position. If rotation is possible, tighten the adjusting screw (M) with clamp lever in the closed position. Do not operate grinder with a loose guard or clamp lever in open position.
5. To remove the guard, open the guard latch, rotate the guard so that the arrows are aligned and pull up on the guard.

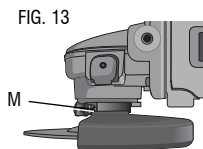
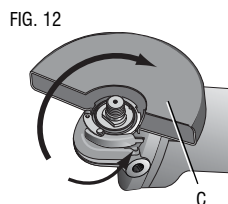
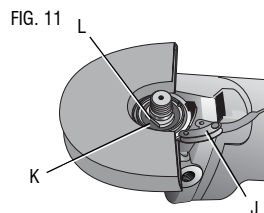

NOTE: If, after a period of time, the guard becomes loose, tighten the adjusting screw (M) with the clamp lever in the closed position.

⚠ CAUTION: Do not tighten adjusting screw with clamp lever in open position. Undetectable damage to guard or mounting hub may result.

MOUNTING CUTTING WHEELS

⚠ WARNING: Turn off and unplug the tool before making any adjustments or removing or installing attachments or accessories. Before reconnecting the tool, turn the switch on and off as previously described to ensure that the tool is off.

⚠ CAUTION: Matching diameter unthreaded backing flange and clamp nut (included with tool) must be used for cutting wheels.

1. Place the unthreaded backing flange on spindle with the raised section (pilot) facing up. The raised section (pilot) on the backing flange will be against the wheel when the wheel is installed.
2. Place the wheel on the backing flange, centering the wheel on the raised section (pilot).
3. Install the threaded clamp nut with the raised section (pilot) facing away from the wheel.
4. Depress the spindle lock button and tighten clamp nut with a wrench.
5. To remove the wheel, grasp and turn while depressing the spindle lock button.

USING CUTTING WHEELS

⚠ WARNING: Do not use edge grinding/ cutting wheels for surface grinding applications because these wheels are not designed for side pressures encountered with surface grinding. Wheel breakage and injury may result.

1. Allow tool to reach full speed before touching tool to work surface.
2. Apply minimum pressure to work surface, allowing tool to operate at high speed. Cutting rate is greatest when the tool operates at high speed.
3. Once a cut is begun and a notch is established in the workpiece, do not change the angle of the cut. Changing the angle will cause the wheel to bend and may cause wheel breakage.
4. Remove the tool from work surface before turning tool off. Allow the tool to stop rotating before setting it down.

Metal Applications

When using the tool in metal applications, make sure that a residual current device (RCD) has been inserted to avoid residual risks caused by metal swarf.

If the power supply is shut off by the RCD, take the tool to authorised DEWALT repair agent.

⚠WARNING: In extreme working conditions, conductive dust can accumulate inside the machine housing when working with metal. This can result in the protective insulation in the machine becoming degraded with a potential risk of an electrical shock.

To avoid build-up of metal swarf inside the machine, we recommend to clear the ventilation slots on a daily basis. Refer to **Cleaning** under **Maintenance** for more information.

Using Flap Discs

⚠WARNING: Shock hazard. Metal dust build-up

Extensive use of flap discs in metal applications can result in the increased potential for electric shock. To reduce this risk, insert an RCD before use and clean the ventilation slots daily by blowing dry compressed air into the ventilation slots in accordance with the below maintenance instructions.

MAINTENANCE

⚠WARNING: To reduce the risk of serious personal injury, turn tool off and disconnect tool from power source before making any adjustments or removing/installing attachments or accessories.

Pop-off Brushes

The motor will be automatically shut off indicating that the carbon brushes are nearly worn out and that the tool needs servicing. The carbon brushes are not user-serviceable. Take the tool to an authorised DEWALT repair agent.

Cleaning

⚠WARNING: Blow dirt and dust out of all air vents with dry air at least once a week. Wear proper ANSI Z87.1 (CAN/CSA Z94.3) eye protection and proper NIOSH/OSHA/MSHA respiratory protection when performing this.

Blowing dust and grit out of motor and switch actuator using clean, dry compressed air is a necessary regular maintenance procedure. Dust and grit containing metal particles often accumulate on interior surfaces and could create an electrical shock or electrocution if not frequently cleaned out. It is recommended that a ground fault circuit interrupter (GFCI) is utilized to further protect the user from electric shock resulting from the accumulation of conductive particles. If the tool is deactivated by the GFCI, unplug the tool and check and clean the tool before resetting the GFCI. Wear proper ANSI Z87.1 (CAN/CSA Z94.3) eye protection and proper NIOSH/OSHA/MSHA respiratory protection when performing this.

⚠WARNING: Never use solvents or other harsh chemicals for cleaning the non-metallic parts of the tool. These chemicals may weaken the plastic materials used in these parts. Use a cloth dampened only with water and mild soap. Never let any liquid get inside the tool; never immerse any part of the tool into a liquid.

Lubrication

DEWALT tools are properly lubricated at the factory and are ready for use.

Repairs

To assure product SAFETY and RELIABILITY, repairs, maintenance and adjustment (including brush inspection and replacement) should be performed by certified service centers or other qualified service organizations, always using identical replacement parts.

ACCESSORIES

⚠WARNING: Since accessories, other than those offered by DEWALT, have not been tested with this product, use of such accessories with this tool could be hazardous. To reduce the risk of injury, only DEWALT, recommended accessories should be used with this product.

Recommended accessories for use with your tool are available at extra cost from your local service center. If you need any assistance in locating any accessory, please contact DEWALT Industrial Tool Co., 20 Fletcher Road, Mooroolbark, VIC 3138 Australia or call 1800 654 155 or (NZ) 0800 339258.

Guarantee

Applicable to hand held Power Tools, Lasers and Nailers.

Three Year Limited Warranty

DeWALT will repair, without charge, any defects due to faulty materials or workmanship for three years from the date of purchase. Please return the complete unit, transportation prepaid, to any DeWALT Service Centre, or any authorised service station.

For warranty repair information, call (AUS) 1800 654 155 or (NZ) 0800 339258.

This warranty does not apply to

- Accessories
- Damage caused where repairs have been made or attempted by others.
- Damage due to misuse, neglect, wear and tear, alteration or modification.

This warranty gives you specific legal rights and you may have other rights under the provisions of the Consumer Guarantee Act 1993 (New Zealand only), Trade Practices Act 1974 and State Legislation (Australia only).

In addition to the warranty, DeWALT tools are covered by our:

FREE ONE YEAR SERVICE CONTRACT

DeWALT will also maintain the tool for free at any time during the first year of purchase. This includes labour, parts and lubrication required to restore the product to sound mechanical and/or electrical condition. Normal wear parts are not covered in this service. Carbon brushes worn more than 50% will be replaced.

NOTE: Three Year Warranty is not applicable to items deemed as consumables. Radial arm saws are covered by a one (1) year warranty only. DeWALT Reserves the right to review its warranty policy prior to launch of any new business development products.

30 DAY NO SATISFACTION GUARANTEE

If you are dissatisfied with any DeWALT power tool, laser or nailer, for any reason, simply return it to the point of purchase with your sales receipt within 30 days for a replacement unit or a full refund.

FREE WARNING LABEL REPLACEMENT: If your warning labels become illegible or are missing, call (AUS) 1800 654 155 or (NZ) 0800 339258 for a free replacement.

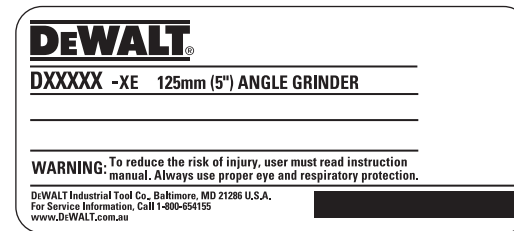



DEWALT Industrial Tool Co.,
20 Fletcher Road, Mooroolbark, VIC 3138 Australia (03 8720 5100) • 5 Te Apunga Place, Mt Wellington, New Zealand (0800 339258)
(OCT09) Part No. N043524 D28116-XE, D28117-XE, D28133-XE, D28136-XE, D28137-XE Copyright © 2009 DEWALT

The following are trademarks for one or more DEWALT power tools: the yellow and black color scheme; the "D" shaped air intake grill; the array of pyramids on the handgrip; the kit box configuration; and the array of lozenge-shaped humps on the surface of the tool.