

INSTRUCTION MANUAL

**DEWALT**®

**XR LI-ION**

**DCS310-XE**

10.8V CORDLESS PIVOT RECIPROCATING SAW



### Definitions: Safety Guidelines

The definitions below describe the level of severity for each signal word. Please read the manual and pay attention to these symbols.

**⚠DANGER:** Indicates an imminently hazardous situation which, if not avoided, **will** result in **death or serious injury**.

**⚠WARNING:** Indicates a potentially hazardous situation which, if not avoided, **could** result in **death or serious injury**.

**⚠CAUTION:** Indicates a potentially hazardous situation which, if not avoided, **may** result in **minor or moderate injury**.

**NOTICE:** Indicates a practice **not related to personal injury** which, if not avoided, **may** result in **property damage**.

IF YOU HAVE ANY QUESTIONS OR COMMENTS ABOUT THIS OR ANY DEWALT TOOL, CALL US AT: 1800 444 224 (Aust) or 0800 339 258 (NZ).

### Technical Data

		DCS310-XE
Voltage	V	10.8
Battery type		Li-Ion
Max. power input	W	140
No-load speed	min <sup>-1</sup>	0–2700
Stroke length	mm	14.3
Weight (without battery pack)	kg	1.2
<hr/>		
L <sub>PA</sub> (sound pressure)	dB(A)	74
K <sub>PA</sub> (sound pressure uncertainty)	dB(A)	3
L <sub>WA</sub> (sound power)	dB(A)	85
K <sub>WA</sub> (sound power uncertainty)	dB(A)	3

Vibration total values (triax vector sum) determined according to EN 60745:

Vibration emission value a<sub>n</sub> while cutting board

a <sub>nB</sub> =	m/s <sup>2</sup>	8.5
Uncertainty K =	m/s <sup>2</sup>	1.5

The vibration emission level given in this information sheet has been measured in accordance with a standardised test given in EN 60745 and may be used to compare one tool with another. It may be used for a preliminary assessment of exposure.

**⚠ WARNING:** The declared vibration emission level represents the main applications of the tool. However if the tool is used for different applications, with different accessories or poorly maintained, the vibration emission may differ. This may significantly increase the exposure level over the total working period.

An estimation of the level of exposure to vibration should also take into account the times when the tool is switched off or when it is running but not actually doing the job. This may significantly reduce the exposure level over the total working period.

Identify additional safety measures to protect the operator from the effects of vibration such as: maintain the tool and the accessories, keep the hands warm, organisation of work patterns.

### SAFETY INSTRUCTIONS FOR POWER TOOLS

When using power tools, always observe the safety regulations applicable in your country to reduce the risk of fire, electric shock and personal injury. Read the following safety instructions before attempting to operate this product. Keep these instructions in a safe place.



**WARNING:** To reduce the risk of injury, read the instruction manual.

### GENERAL POWER TOOL SAFETY WARNINGS



**WARNING! Read all safety warnings and all instructions** Failure to follow the warnings and instructions may result in electric shock, fire and/or serious injury.

The term "power tool" in the warnings refers to your mains-operated (corded) power tool or battery-operated (cordless) power tool.

## **SAVE THESE INSTRUCTIONS**

### **1) WORK AREA SAFETY**

- a) **Keep work area clean and well lit.** Cluttered or dark areas invite accidents.
- b) **Do not operate power tools in explosive atmospheres, such as in the presence of flammable liquids, gases or dust.** Power tools create sparks which may ignite the dust or fumes.
- c) **Keep children and bystanders away while operating a power tool.** Distractions can cause you to lose control.

### **2) ELECTRICAL SAFETY**

- a) **Power tool plugs must match the outlet. Never modify the plug in any way. Do not use any adapter plugs with earthed (grounded) power tools.** Unmodified plugs and matching outlets will reduce risk of electric shock.
- b) **Avoid body contact with earthed or grounded surfaces such as pipes, radiators, ranges and refrigerators.** There is an increased risk of electric shock if your body is earthed or grounded.
- c) **Do not expose power tools to rain or wet conditions.** Water entering a power tool will increase the risk of electric shock.
- d) **Do not abuse the cord. Never use the cord for carrying, pulling or unplugging the power tool. Keep cord away from heat, oil, sharp edges or moving parts.** Damaged or entangled cords increase the risk of electric shock.
- e) **When operating a power tool outdoors, use an extension cord suitable for outdoor use.** Use of a cord suitable for outdoor use reduces the risk of electric shock.
- f) **If operating a power tool in a damp location is unavoidable, use a residual current device (RCD) protected supply.** Use of an RCD reduces the risk of electric shock.

### **3) PERSONAL SAFETY**

- a) **Stay alert, watch what you are doing and use common sense when operating a power tool. Do not use a power tool while you are tired or under the influence of drugs, alcohol or medication.** A moment of inattention while operating power tools may result in serious personal injury.

- b) **Use personal protective equipment. Always wear eye protection.** Protective equipment such as dust mask, non-skid safety shoes, hard hat, or hearing protection used for appropriate conditions will reduce personal injuries.
  - c) **Prevent unintentional starting. Ensure the switch is in the off position before connecting to power source and/or battery pack, picking up or carrying the tool.** Carrying power tools with your finger on the switch or energising power tools that have the switch on invites accidents.
  - d) **Remove any adjusting key or wrench before turning the power tool on.** A wrench or a key left attached to a rotating part of the power tool may result in personal injury.
  - e) **Do not overreach. Keep proper footing and balance at all times.** This enables better control of the power tool in unexpected situations.
  - f) **Dress properly. Do not wear loose clothing or jewellery. Keep your hair, clothing and gloves away from moving parts.** Loose clothes, jewellery or long hair can be caught in moving parts.
  - g) **If devices are provided for the connection of dust extraction and collection facilities, ensure these are connected and properly used.** Use of dust collection can reduce dust-related hazards.
- ### **4) POWER TOOL USE AND CARE**
- a) **Do not force the power tool. Use the correct power tool for your application.** The correct power tool will do the job better and safer at the rate for which it was designed.
  - b) **Do not use the power tool if the switch does not turn it on and off.** Any power tool that cannot be controlled with the switch is dangerous and must be repaired.
  - c) **Disconnect the plug from the power source and/or the battery pack from the power tool before making any adjustments, changing accessories, or storing power tools.** Such preventive safety measures reduce the risk of starting the power tool accidentally.
  - d) **Store idle power tools out of the reach of children and do not allow persons unfamiliar with the power tool or these instructions to operate the power tool.** Power tools are dangerous in the hands of untrained users.
  - e) **Maintain power tools. Check for misalignment or binding of moving parts, breakage of parts and any other condition that may affect the power tool's**

**operation. If damaged, have the power tool repaired before use.** Many accidents are caused by poorly maintained power tools.

- f) **Keep cutting tools sharp and clean.** Properly maintained cutting tools with sharp cutting edges are less likely to bind and are easier to control.
- g) **Use the power tool, accessories and tool bits, etc., in accordance with these instructions, taking into account the working conditions and the work to be performed.** Use of the power tool for operations different from those intended could result in a hazardous situation.

#### 5) BATTERY TOOL USE AND CARE

- a) **Recharge only with the charger specified by the manufacturer.** A charger that is suitable for one type of battery pack may create a risk of fire when used with another battery pack.
- b) **Use power tools only with specifically designated battery packs.** Use of any other battery packs may create a risk of injury and fire.
- c) **When battery pack is not in use, keep it away from other metal objects like paper clips, coins, keys, nails, screws, or other small metal objects that can make a connection from one terminal to another.** Shorting the battery terminals together may cause burns or a fire.
- d) **Under abusive conditions, liquid may be ejected from the battery; avoid contact. If contact accidentally occurs, flush with water. If liquid contacts eyes, additionally seek medical help.** Liquid ejected from the battery may cause irritation or burns.

#### 6) SERVICE

- a) **Have your power tool serviced by a qualified repair person using only identical replacement parts.** This will ensure that the safety of the power tool is maintained.

#### *Electrical Safety*

The electric motor has been designed for one voltage range only. Always check that the power supply corresponds to the voltage on the rating plate. 220–240 V AC means your tool will operate on alternating current. Operation at a voltage outside this range can cause loss of power and can result in overheating. All DEWALT tools are factory tested; if this tool does not operate, check the power supply. Your DEWALT tool is double insulated, therefore no earth wire is required.

- **Young children and the infirm.** This appliance is not intended for use by young children or infirm persons without supervision.
  - This appliance is not intended for use by persons (including children) with reduced physical, sensory or mental capabilities, or lack of experience and knowledge, unless they have been given supervision or instruction concerning use of the appliance by a person responsible for their safety.
  - Children should be supervised to ensure that they do not play with the appliance.
- **Replacement of the supply cord.** If the supply cord or plug is damaged, it must be replaced by the manufacturer or an authorised DEWALT Service Centre in order to avoid a hazard.

#### *Extension Cords*

**⚠ CAUTION:** Use only extension cords that are approved by the country's Electrical Authority. Before using extension cords, inspect them for loose or exposed wires, damaged insulation and defective fittings. Replace the cord if necessary.

#### *Additional Specific Safety Rules for Reciprocating Saws*

- **Hold power tool by insulated gripping surfaces, when performing an operation where the cutting accessory may contact hidden wiring.** Cutting accessory contacting a "live" wire may make exposed metal parts of the power tool "live" and could give the operator an electric shock.
- **Use clamps or another practical way to secure and support the workpiece to a stable platform. Holding the work by hand or against your body leaves it unstable and may lead to loss of control.**
- **Hold saw firmly with both hands for all cutting operations.** During cutting operations, the blade may suddenly bind in the work and may cause the saw to kickback towards the operator.
- **Keep hands away from moving parts.** Never place your hands near the cutting area.
- **Use extra caution when cutting overhead and pay particular attention to overhead wires which may be hidden from view.** Anticipate the path of falling branches and debris ahead of time.
- **Do not operate this tool for long periods of time.** Vibration caused by the operating action of this tool may cause permanent injury to fingers, hands, and arms. Use gloves to provide extra cushion, take frequent rest periods, and limit daily time of use.

- **Air vents often cover moving parts and should be avoided.** Loose clothes, jewellery or long hair can be caught in moving parts.

**⚠ WARNING:** We recommend the use of a residual current device with a residual current rating of 30mA or less.

**⚠ WARNING: ALWAYS wear approved protective safety equipment complying with the following standards:**

- Eye protection: AS/NZS1337 Eye Protectors for Industrial Applications;
- Hearing protection: AS/NZS1270 Acoustics – Hearing Protection;
- Respiratory protection: AS/NZS1716 Respiratory Protective Devices.

**⚠ WARNING:** Some dust created by power sanding, sawing, grinding, drilling, and other construction activities contains chemicals known to cause cancer, birth defects or other reproductive harm. Some examples of these chemicals are:

- lead from lead-based paints,
- crystalline silica from bricks and cement and other masonry products, and
- arsenic and chromium from chemically-treated lumber.

Your risk from these exposures varies, depending on how often you do this type of work. To reduce your exposure to these chemicals: work in a well ventilated area, and work with approved safety equipment, such as those dust masks that are specially designed to filter out microscopic particles.



- **Avoid prolonged contact with dust from power sanding, sawing, grinding, drilling, and other construction activities. Wear protective clothing and wash exposed areas with soap and water.** Allowing dust to get into your mouth, eyes, or lay on the skin may promote absorption of harmful chemicals.

**⚠ WARNING:** Use of this tool can generate and/or disburse dust, which may cause serious and permanent respiratory or other injury. Always use approved respiratory protection appropriate for the dust exposure. Direct particles away from face and body.

**⚠ WARNING:** Always wear proper personal hearing protection that conforms to AS/NZS1270 during use. Under some conditions and duration of use, noise from this product may contribute to hearing loss.

**⚠ CAUTION:** When not in use, place tool on its side on a stable surface where it will not cause a tripping or falling hazard. Some tools with large battery packs will stand upright on the battery pack but may be easily knocked over.

- The label on your tool may include the following symbols. The symbols and their definitions are as follows:

V .....	volts	A .....	amperes
Hz .....	hertz	W .....	watts
min .....	minutes	~ .....	alternating current
— — .....	direct current	⌚ .....	alternating or direct current
 .....	Class I Construction (grounded)	no .....	no load speed
 .....	Class II Construction (double insulated)	⊕ .....	earthing terminal
.../min .....	per minute	 .....	safety alert symbol
IPM .....	impacts per minute	BPM .....	beats per minute
		RPM .....	revolutions per minute

### **Important Safety Instructions for All Battery Packs**

When ordering replacement battery packs, be sure to include catalog number and voltage. Consult the chart at the end of this manual for compatibility of chargers and battery packs.

The battery pack is not fully charged out of the carton. Before using the battery pack and charger, read the safety instructions below. Then follow charging procedures outlined.

### **READ ALL INSTRUCTIONS**

- **Do not charge or use battery in explosive atmospheres, such as in the presence of flammable liquids, gases or dust.** Inserting or removing the battery from the charger may ignite the dust or fumes.
- **Never force battery pack into charger. Do not modify battery pack in any way to fit into a non-compatible charger as battery pack may rupture causing serious personal injury.** Consult the chart at the end of this manual for compatibility of batteries and chargers.
- Charge the battery packs only in DEWALT chargers.
- **DO NOT** splash or immerse in water or other liquids.
- **Do not store or use the tool and battery pack in locations where the temperature may reach or exceed 40 °C (105 °F) (such as outside sheds or metal buildings in summer).**

**⚠ WARNING:** Fire hazard. Never attempt to open the battery pack for any reason. If battery pack case is cracked or damaged, do not insert into charger. Do not crush, drop or damage battery pack. Do not use a battery pack or charger that has received a sharp blow, been dropped, run over or damaged in any way (i.e., pierced with a nail, hit with a hammer, stepped on). Damaged battery packs should be returned to service center for recycling.

**⚠ WARNING:** Fire hazard. Do not store or carry battery so that metal objects can contact exposed battery terminals. For example, do not place battery in aprons, pockets, tool boxes, product kit boxes, drawers, etc., with loose nails, screws, keys, etc. **Transporting batteries can possibly cause fires if the battery terminals inadvertently come in contact with conductive materials such as keys, coins, hand tools and the like.** The US Department of Transportation Hazardous Material Regulations (HMR) actually prohibit transporting batteries in commerce or on airplanes (i.e., packed in suitcases and carry-on luggage) UNLESS they are properly protected from short circuits. So when transporting individual batteries, make sure that the battery terminals are protected and well insulated from materials that could contact them and cause a short circuit.

#### **SPECIFIC SAFETY INSTRUCTIONS FOR LITHIUM ION (Li-Ion)**

- **Do not incinerate the battery pack even if it is severely damaged or is completely worn out.** The battery pack can explode in a fire. Toxic fumes and materials are created when lithium ion battery packs are burned.
- **If battery contents come into contact with the skin, immediately wash area with mild soap and water.** If battery liquid gets into the eye, rinse water over the open eye for 15 minutes or until irritation ceases. If medical attention is needed, the battery electrolyte is composed of a mixture of liquid organic carbonates and lithium salts.
- **Contents of opened battery cells may cause respiratory irritation. Provide fresh air.** If symptoms persists, seek medical attention.

**⚠ WARNING:** Burn hazard. Battery liquid may be flammable if exposed to spark or flame.

#### **Important Safety Instructions for All Battery Chargers**

**SAVE THESE INSTRUCTIONS:** This manual contains important safety and operating instructions for battery chargers.

- Before using charger, read all instructions and cautionary markings on charger, battery pack, and product using battery pack.

**⚠ WARNING:** Shock hazard. Do not allow any liquid to get inside charger. Electric shock may result.

**⚠ CAUTION:** Burn hazard. To reduce the risk of injury, charge only DEWALT rechargeable batteries. Other types of batteries may burst causing personal injury and damage.

**NOTICE:** Under certain conditions, with the charger plugged in to the power supply, the charger can be shorted by foreign material. Foreign materials of a conductive nature such as, but not limited to, grinding dust, metal chips, steel wool, aluminum foil, or any buildup of metallic particles should be kept away from charger cavities. Always unplug the charger from the power supply when there is no battery pack in the cavity. Unplug charger before attempting to clean.

- **DO NOT attempt to charge the battery pack with any chargers other than the ones in this manual.** The charger and battery pack are specifically designed to work together.
- **These chargers are not intended for any uses other than charging DEWALT rechargeable batteries.** Any other uses may result in risk of fire, electric shock or electrocution.
- **Do not expose charger to rain or snow.**
- **Pull by plug rather than cord when disconnecting charger.** This will reduce risk of damage to electric plug and cord.
- **Make sure that cord is located so that it will not be stepped on, tripped over, or otherwise subjected to damage or stress.**
- **Do not use an extension cord unless it is absolutely necessary.** Use of improper extension cord could result in risk of fire, electric shock, or electrocution.
- **When operating a power tool outdoors, use an extension cord suitable for outdoor use.** Use of a cord suitable for outdoor use reduces the risk of electric shock.
- **Do not place any object on top of charger or place the charger on a soft surface that might block the ventilation slots and result in excessive internal heat.** Place the charger in a position away from any heat source. The charger is ventilated through slots in the top and the bottom of the housing.





### LEAVING THE BATTERY PACK IN THE CHARGER

The charger and battery pack can be left connected with the charge indicator showing Pack Charged.

**WEAK BATTERY PACKS:** Weak batteries will continue to function but should not be expected to perform as much work.

**FAULTY BATTERY PACKS:** This charger will not charge a faulty battery pack. The charger will indicate faulty battery pack by refusing to light or by displaying problem pack or charger.

**NOTE:** This could also mean a problem with a charger.

### Important Charging Notes

1. Longest life and best performance can be obtained if the battery pack is charged when the air temperature is between 18 and 24 °C (65 and 75 °F). DO NOT charge the battery pack in an air temperature below +4 °C (+40 °F), or above +40 °C (+105 °F). This is important and will prevent serious damage to the battery pack.
2. The charger and battery pack may become warm to touch while charging. This is a normal condition, and does not indicate a problem. To facilitate the cooling of the battery pack after use, avoid placing the charger or battery pack in a warm environment such as in a metal shed, or an uninsulated trailer.
3. If the battery pack does not charge properly:
  - a. Check operation of receptacle by plugging in a lamp or other appliance;
  - b. Check to see if receptacle is connected to a light switch which turns power off when you turn out the lights;
  - c. Move charger and battery pack to a location where the surrounding air temperature is approximately 18–24 °C (65–75 °F);
  - d. If charging problems persist, take the tool, battery pack and charger to your local service center.
4. The battery pack should be recharged when it fails to produce sufficient power on jobs which were easily done previously. DO NOT CONTINUE to use under these conditions. Follow the charging procedure. You may also charge a partially used pack whenever you desire with no adverse affect on the battery pack.
5. Foreign materials of a conductive nature such as, but not limited to, grinding dust, metal chips, steel wool, aluminum foil, or any buildup of metallic particles

should be kept away from charger cavities. Always unplug the charger from the power supply when there is no battery pack in the cavity. Unplug charger before attempting to clean.

6. Do not freeze or immerse charger in water or any other liquid.

**⚠ WARNING:** Shock hazard. Don't allow any liquid to get inside charger. Electric shock may result.

**⚠ CAUTION:** Never attempt to open the battery pack for any reason. If the plastic housing of the battery pack breaks or cracks, return to a service center for recycling.

### Storage Recommendations

1. The best storage place is one that is cool and dry away from direct sunlight and excess heat or cold.
2. For long storage, it is recommended to store a fully charged battery pack in a cool dry place out of the charger for optimal results.

**NOTE:** Battery packs should not be stored completely depleted of charge. The battery pack will need to be recharged before use.

## SAVE ALL WARNINGS AND INSTRUCTIONS FOR FUTURE REFERENCE

### COMPONENTS (Fig. 2)

**⚠ WARNING:** Never modify the power tool or any part of it. Damage or personal injury could result.

- |                                  |                              |
|----------------------------------|------------------------------|
| A. Variable speed trigger switch | G. Blade clamp release lever |
| B. Lock-off button               | H. Main handle               |
| C. Pivot release slider          | I. Hand grip                 |
| D. Shoe                          | J. Battery pack              |
| E. LED worklight                 | K. Battery release button    |
| F. Blade clamp                   |                              |

### INTENDED USE

This reciprocating saw is designed for professional cutting of wood, metal, plastic and drywall.

**DO NOT** use under wet conditions or in presence of flammable liquids or gases.

This reciprocating saw is a professional power tool. **DO NOT** let children come into contact with the tool. Supervision is required when inexperienced operators use this tool.

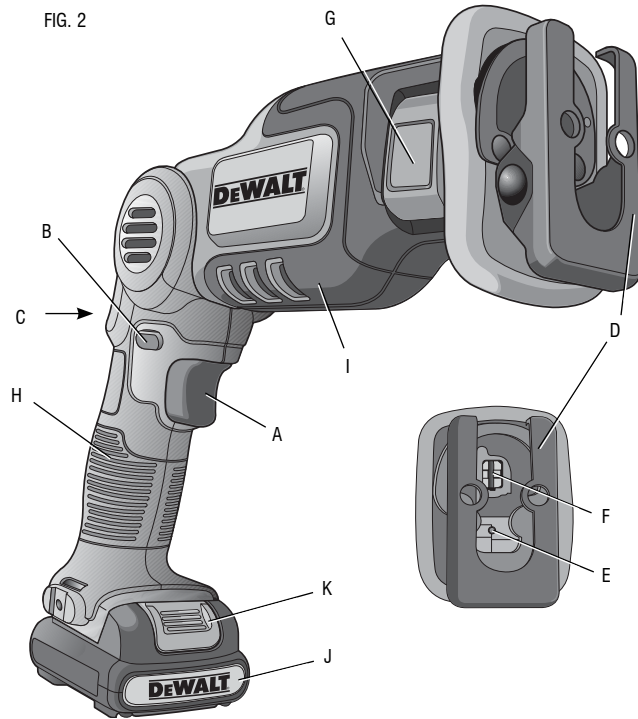

## OPERATION

**⚠ WARNING:** To reduce the risk of serious personal injury, lock the trigger switch and disconnect battery pack before making any adjustments or removing/installing attachments or accessories. An accidental start-up can cause injury.

### **Variable Speed Trigger Switch (Fig. 2)**

To turn the tool on, squeeze the variable speed trigger switch (A). To turn the tool off, release the variable speed trigger switch.

The trigger switch enables you to start the application at a slow speed. The further you depress the trigger, the faster the tool will operate.

**⚠ WARNING:** This tool has no provision to lock the switch in the on position and should never be locked on by any other means.

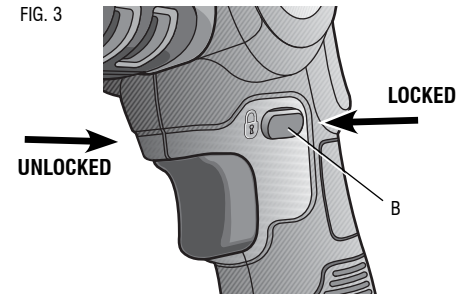

### **LOCK-OFF BUTTON (FIG. 3)**

Your saw is equipped with a lock-off button (B).

To lock the trigger switch (A), press the lock-off button as shown in Figure 3. When the lock-off button is depressed to the lock icon, the tool is locked. Always lock the trigger switch when carrying or storing the tool to eliminate unintentional starting.

**NOTICE:** Use of very slow speed is recommended only for beginning a cut. Prolonged use at very slow speed may damage your saw.

### Proper Hand Position (Fig. 4)

**▲ WARNING:** To reduce the risk of serious personal injury, **ALWAYS** use proper hand position as shown.

**▲ WARNING:** To reduce the risk of serious personal injury, **ALWAYS** hold securely in anticipation of a sudden reaction.

Proper hand position requires one hand on the hand grip (I), with the other hand on the main handle (H).

FIG. 4

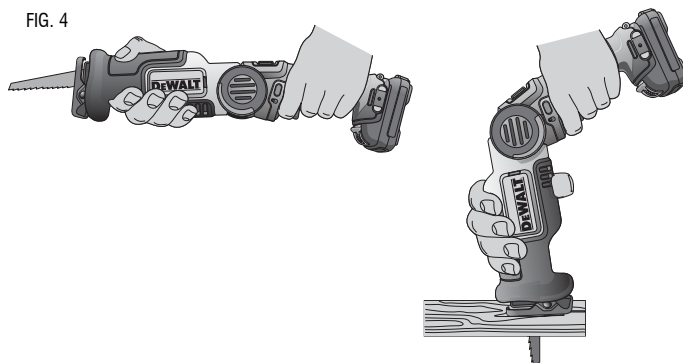

### Installing and Removing the Battery Pack (Fig. 5)

**▲ WARNING:** To reduce the risk of injury, never depress the battery release button without removing the battery pack. Depressing the battery release button without removing the battery pack can result in the battery pack falling out unexpectedly.

**NOTE:** For best results, make sure your battery pack is fully charged.

To install the battery pack (J) into the tool handle, align the battery pack with the rails inside the tool's handle and slide it into the handle until the battery pack is firmly seated in the tool and ensure that it does not disengage.

To remove the battery pack from the tool, press the release button (K) and firmly pull the battery pack out of the tool handle. Insert it into the charger as described in the charger section of this manual.

FIG. 5

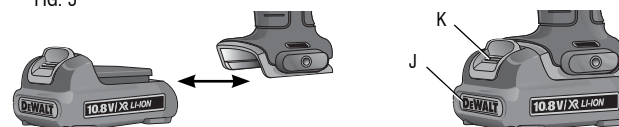

### Pivot Release Slider (Fig. 6)

**▲ WARNING:** To avoid tool being turned on accidentally, make sure the lock-off button (B) is engaged.

**▲ WARNING:** To avoid being pinched, keep hands away from the hinge when changing positions.

The tool can be converted into three different positions. To change positions, slide the pivot release slider (C) to the right as shown in Figure 6 and rotate the handle portion of the tool into any of the three positions shown in Figure 7.

FIG. 6

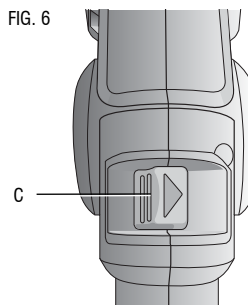

FIG. 7



### Blade Installation and Removal (Fig. 8, 9A, 9B, 9C)

**▲ WARNING:** To reduce the risk of serious personal injury, lock the trigger switch and disconnect battery pack before making any adjustments or removing/installing attachments or accessories. An accidental start-up can cause injury.

Different blade lengths are available. Use the appropriate blade for the application. The blade should be longer than 89 mm (3-1/2") and should extend past the shoe and the thickness of the workpiece during the cut. A 102 mm (4") blade is recommended for best performance. Do not use jigsaw blades with this tool.

**⚠WARNING:** Cut hazard. Blade breakage may occur if the blade does not extend past the shoe and the workpiece during the cut (Fig. 8). Increased risk of personal injury, as well as damage to the shoe and workpiece may result.

FIG. 8

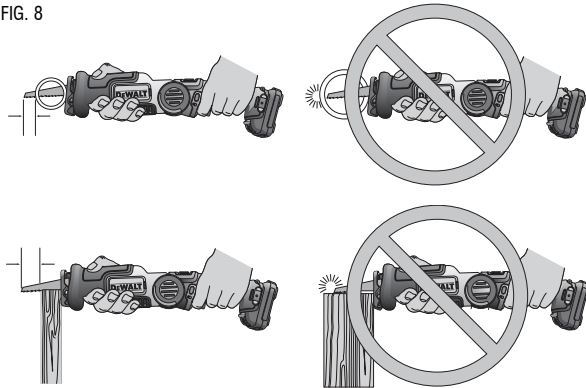

**TO INSTALL BLADE INTO SAW (FIG. 9A, 9B, 9C)**

1. Pull blade clamp release lever (G) up.
2. Insert the blade shank into the blade clamp (F, Fig. 9C).
3. Close blade clamp release lever.
4. Note that the blade can be installed upside-down to assist in flush-to cutting (refer to Fig. 9B).

**TO REMOVE BLADE FROM SAW (FIG. 9A, 9B, 9C)**

**⚠CAUTION:** Burn hazard. Do not touch the the blade immediately after use. Contact with the blade may result in personal injury.

1. Pull blade clamp release lever (G) up.
2. Remove blade.

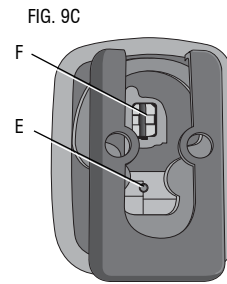
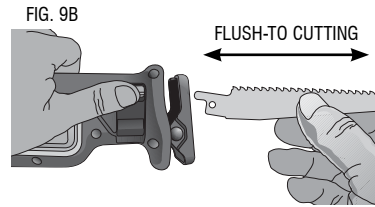
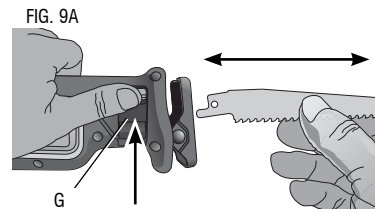

**Worklight (Fig. 9C)**

The worklight (E) is located below the blade clamp (F) behind the shoe. The worklight will be activated when the trigger switch is squeezed.

**NOTE:** The worklight is for lighting the immediate work surface and is not intended to be used as a flashlight.

**Cutting (Fig. 10–13)**

**⚠WARNING:** Always use eye protection. All users and bystanders must wear eye protection that conforms to AS/NZS1337.

**⚠WARNING:** Exercise extra caution when cutting towards operator. Always hold saw firmly with both hands while cutting.

Before cutting any type of material, be sure it is firmly anchored or clamped to prevent slipping. Place blade lightly against work to be cut, switch on saw motor and allow it to obtain maximum speed before applying pressure. Whenever possible, the saw shoe must be held firmly against the material being cut. This will prevent the saw from

jumping or vibrating and minimize blade breakage. Any cuts which put pressure on the blade such as angle or scroll cuts increase potential for vibration, kickback, and blade breakage.

**⚠WARNING:** Use extra caution when cutting overhead and pay particular attention to overhead wires which may be hidden from view. Anticipate the path of falling branches and debris ahead of time.

**⚠WARNING:** Inspect work site for hidden gas pipes, water pipes, or electrical wires before making blind or plunge cuts. Failure to do so may result in explosion, property damage, electric shock, and/or serious personal injury.

**FLUSH-TO CUTTING (FIG. 9B, 10)**

The compact design of the saw motor housing and spindle housing permits extremely close cutting to floors, corners and other difficult areas. The blade should be inserted upside-down to assist in flush-cutting (Fig. 9B).

**POCKET/PLUNGE CUTTING – WOOD ONLY (FIG. 11)**

The initial step in pocket cutting is to measure the surface area to be cut and mark clearly with a pencil, chalk or scribe. Use the appropriate blade for the application. The blade should be longer than 89 mm (3-1/2") and should extend past the shoe and the thickness of the workpiece during the cut. A 102 mm (4") blade is recommended for best performance. Insert blade into the blade clamp.

Next, tip the saw backward until the back edge of the shoe is resting on the work surface and the blade clears the work surface (Fig. 11, position 1). Then, squeeze the trigger switch and

FIG. 10

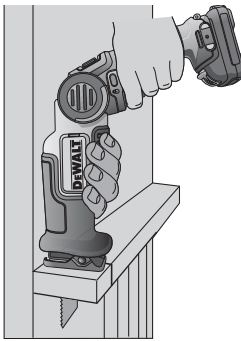
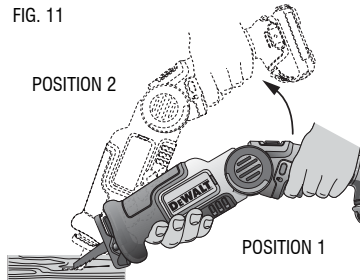

FIG. 11



allow saw to come up to speed. Grip saw firmly with both hands and begin a slow, deliberate upward swing with the handle of the saw, keeping the bottom of the shoe firmly in contact with the workpiece (Fig. 11, position 2). Blade will begin to feed into material. Always be sure blade is completely through material before continuing with pocket cut.

**NOTE:** In areas where blade visibility is limited, use the edge of the saw shoe as a guide. Lines for any given cut should be extended beyond edge of cut to be made.

**METAL CUTTING (FIG. 12)**

Your saw has different metal cutting capacities depending upon type of blade used and the metal to be cut. Use a finer blade for ferrous metals and a coarse blade for non-ferrous materials. In thin gauge sheet metals it is best to clamp wood to both sides of sheet. This will ensure a clean cut without excess vibration or tearing of metal. Always remember not to force cutting blade as this reduces blade life and causes costly blade breakage.

**NOTE:** It is generally recommended that when cutting metals you should spread a thin film of oil or other lubricant along the line ahead of the saw cut for easier operation and longer blade life.

FIG. 12

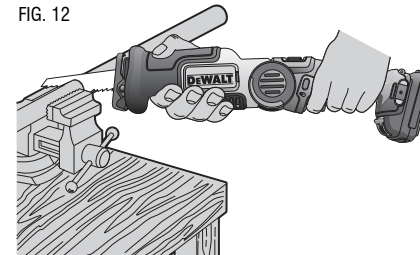

**HORIZONTAL/VERTICAL SAW MODES (FIG. 13)**

The saw can be used in either of the modes shown.

**Horizontal Mode:** Blade teeth face downward as shown in Figure 13A.

**Vertical Mode:** Blade teeth face forward as shown in Figure 13B.

The DCS310-XE can accept all lengths of reciprocating blades. For best results use 102 mm (4") blades. Ensure the blade extends past the shoe and the thickness of

the workpiece during the cut. Use a longer blade if needed. Whenever possible, the saw shoe must be held firmly against the material being cut. This will prevent the saw from jumping or vibrating and minimize blade breakage.

FIG. 13A

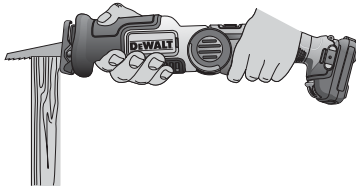

FIG. 13B



## MAINTENANCE

**⚠ WARNING:** To reduce the risk of serious personal injury, lock the trigger switch and disconnect battery pack before making any adjustments or removing/installing attachments or accessories. An accidental start-up can cause injury.

### Lubrication

Your power tool requires no additional lubrication.

### Cleaning

**⚠ WARNING:** Blow dirt and dust out of all air vents with clean, dry air at least once a week. To minimize the risk of eye injury, always wear AS/NZS1337 approved eye protection when performing this.

**⚠ WARNING:** Never use solvents or other harsh chemicals for cleaning the non-metallic parts of the tool. These chemicals may weaken the plastic materials used in these parts. Use a cloth dampened only with water and mild soap. Never let any liquid get inside the tool; never immerse any part of the tool into a liquid.

## Repairs

To assure product SAFETY and RELIABILITY, repairs, maintenance and adjustment (including brush inspection and replacement) should be performed by certified service centers or other qualified service organizations, always using identical replacement parts.

## ACCESSORIES

**⚠ WARNING:** Since accessories, other than those offered by DEWALT, have not been tested with this product, use of such accessories with this tool could be hazardous. To reduce the risk of injury, only DEWALT recommended accessories should be used with this product.

Recommended accessories for use with your tool are available at extra cost from your local service center. If you need any assistance in locating any accessory, please contact Stanley Black & Decker, 82 Taryn Drive, Epping, VIC 3076 Australia or call 1800 444 224 or (NZ) 0800 339 258.



DeWALT BATTERY AND CHARGER SYSTEMS																								
Battery		Chargers/Charge Time																						
Output Nominal		240 Volts																		12 Volts				
Cat. Number	Voltage	Amp Hour	97014	98014	DW9106	DW9107	DW9108	DW9115	DW9116	DW9117	DW9118	DE9116	DE9118	DW911	DC011	DW0245	DE2046	DE9000	DC9310	DCB100	DCB105	DCB119	DW9109	DC9319
DC9360	36	2.2	X	X	X	X	X	X	X	X	X	X	X	X	X	X	X	60	X	X	X	X	X	X
DE0240-XJ	24	2.0	X	X	X	X	X	X	X	X	X	X	X	X	X	60	60	X	X	X	X	X	X	X
DW0242	24	2.0	X	X	X	X	X	X	X	X	X	X	X	X	X	60	60	X	X	X	X	X	X	X
DW0240	24	1.7	X	X	X	X	X	X	X	X	X	X	X	X	X	60	60	X	X	X	X	X	X	X
DC9096	18	2.4	X	X	X	X	60	X	60	20	X	60	X	60	60	X	X	X	60	X	X	X	60	60
DC9180	18	2.0	X	X	X	X	X	X	X	X	X	X	X	X	X	X	X	X	60	X	X	X	X	60
DCB180	18	3.0	X	X	X	X	X	X	X	X	X	X	X	X	X	X	X	X	X	X	60	90	X	X
DCB181	18	1.5	X	X	X	X	X	X	X	X	X	X	X	X	X	X	X	X	X	X	30	40	X	X
DW9096	18	2.4	X	X	X	X	60	X	60	20	X	60	X	60	60	X	X	X	60	X	X	X	60	60
DE9095-XJ	18	2.0	X	X	X	X	60	X	60	20	X	60	X	60	60	X	X	X	60	X	X	X	60	60
DC9091	14.4	2.4	60	60	60	60	60	15	60	15	60	60	60	60	60	X	X	X	60	X	X	X	60	60
DC9144	14.4	2.0	X	X	X	X	X	X	X	X	X	X	X	X	X	X	X	X	60	X	X	X	X	60
DE9094	14.4	1.3	45	45	45	30	30	15	30	12	60	30	60	30	30	X	X	X	30	X	X	X	30	30
DE9091-XJ	14.4	2.0	45	45	45	45	45	15	45	15	90	45	90	45	45	X	X	X	45	X	X	X	45	45
DW9091	14.4	1.7	45	45	45	45	45	15	45	15	90	45	90	45	45	X	X	X	45	X	X	X	45	45
DC9071	12	2.4	60	60	60	60	60	15	60	15	60	60	60	60	60	X	X	X	60	X	X	X	60	60
DE9071-XJ	12	2.0	60	60	60	45	45	15	45	15	90	45	90	45	45	X	X	X	45	X	X	X	45	45
DE9074-XJ	12	1.25	45	45	45	30	30	15	30	12	60	30	60	30	30	X	X	X	30	X	X	X	30	30
DW9050	12	1.3	40	40	40	X	X	15	X	X	X	X	X	X	X	X	X	X	X	X	X	X	X	X
DW9071	12	1.7	60	60	60	45	45	15	45	15	90	45	90	45	45	X	X	X	45	X	X	X	45	45
DW9072	12	1.2	45	45	45	30	30	15	30	12	60	30	60	30	30	X	X	X	30	X	X	X	30	30
DCB120	10.8	1.3	X	X	X	X	X	X	X	X	X	X	X	X	X	X	X	X	X	40	40	40	X	X
DCB123	10.8	1.5	X	X	X	X	X	X	X	X	X	X	X	X	X	X	X	X	X	40	40	40	X	X
DW9063	9.6	1.25	45	45	45	30	30	15	30	12	60	30	60	30	30	X	X	X	30	X	X	X	30	30
DW9062	9.6	1.3	45	45	45	30	30	15	30	12	60	30	60	30	30	X	X	X	30	X	X	X	30	30
DW9061	9.6	1.7	60	60	60	45	45	15	45	15	90	45	90	45	45	X	X	X	45	X	X	X	45	45
DW9048	9.6	1.3	40	40	40	X	X	15	X	X	X	X	X	X	X	X	X	X	X	X	X	X	X	X
DW9057	7.2	1.25	45	45	45	30	30	15	30	12	60	30	60	30	30	X	X	X	30	X	X	X	30	30
DW9046	7.2	1.3	40	40	40	X	X	15	X	X	X	X	X	X	X	X	X	X	X	X	X	X	X	X

X Indicates that the battery pack is not compatible with that specific charger.  
 All charge times are approximate. Actual charge time may vary.  
 Read the instruction manual for more specific information.  
 The battery voltage is nominal, it can measure above or below depending on the state of charge.

Stanley Black & Decker  
 82 Taryn Drive, Epping, VIC 3076 Australia • 1800 444 224 (Aust) or 0800 339 258 (NZ)  
 www.dewalt.com.au • www.dewalt.com.nz

(JAN12) Part No. N160216 DCS310-XE Copyright © 2012 DeWALT

The following are trademarks for one or more DeWALT power tools: the yellow and black color scheme; the "D" shaped air intake grill; the array of pyramids on the handgrip; the kit box configuration; and the array of lozenge-shaped humps on the surface of the tool.